

Economical sized insert with
no compromise in performance

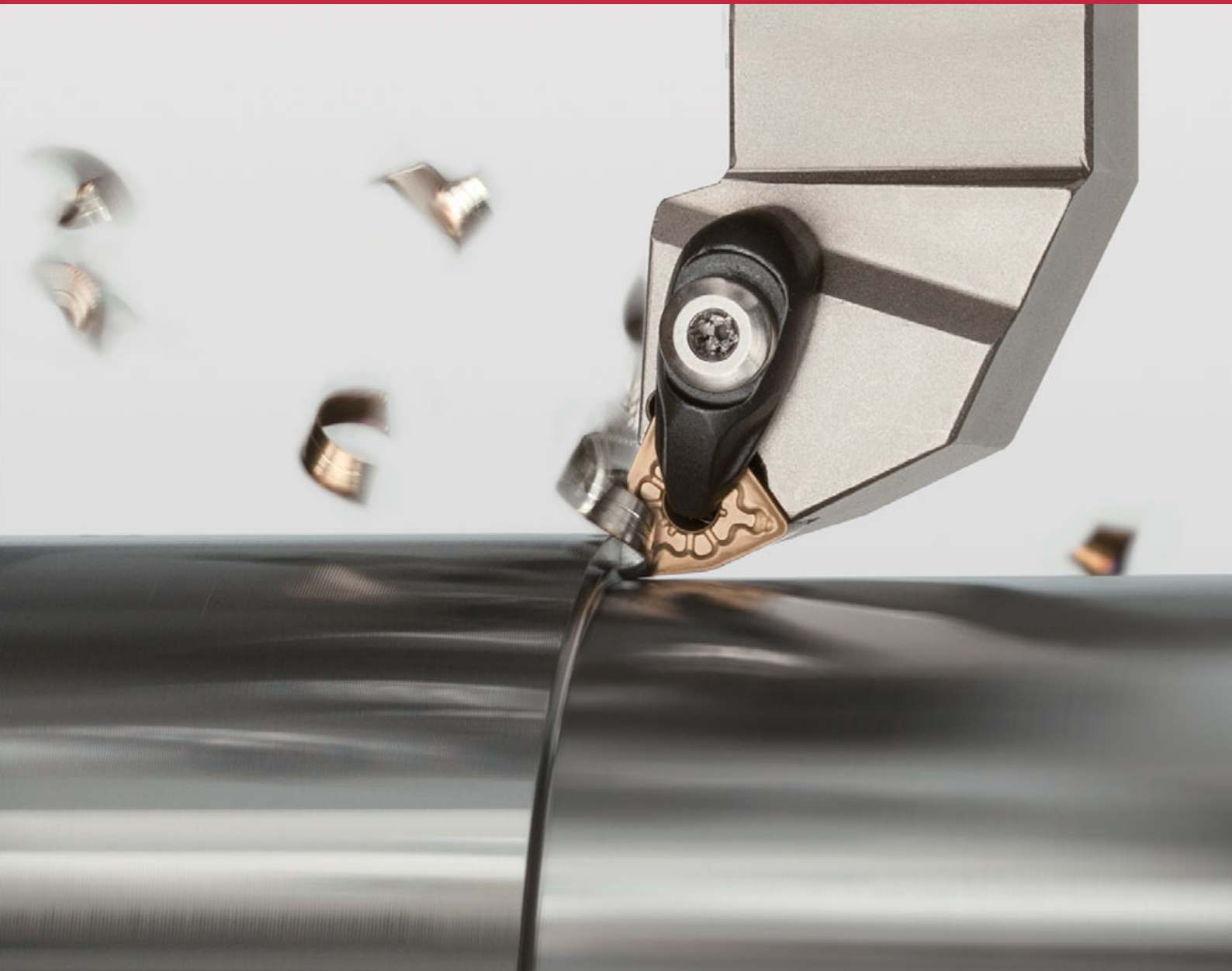

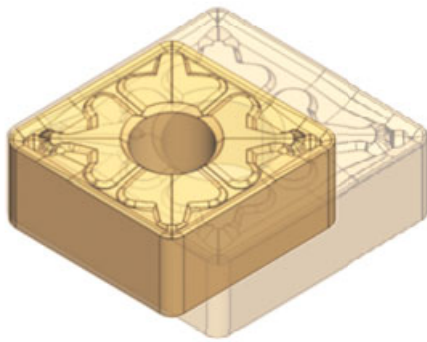

ACCELERATED MACHINING



ISO ETURN
CNMG090408E type

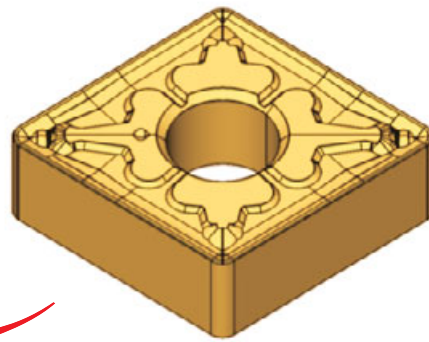

Regular size inserts
CNMG120408 type



Cost effective:
Identical cutting performance, only smaller

ISO-EcoTurn Small size inserts, for an economical advantage

Over 75%* of the turning market only uses a depth of cut at or less than 3 mm

* Based on Tungaloy market research.

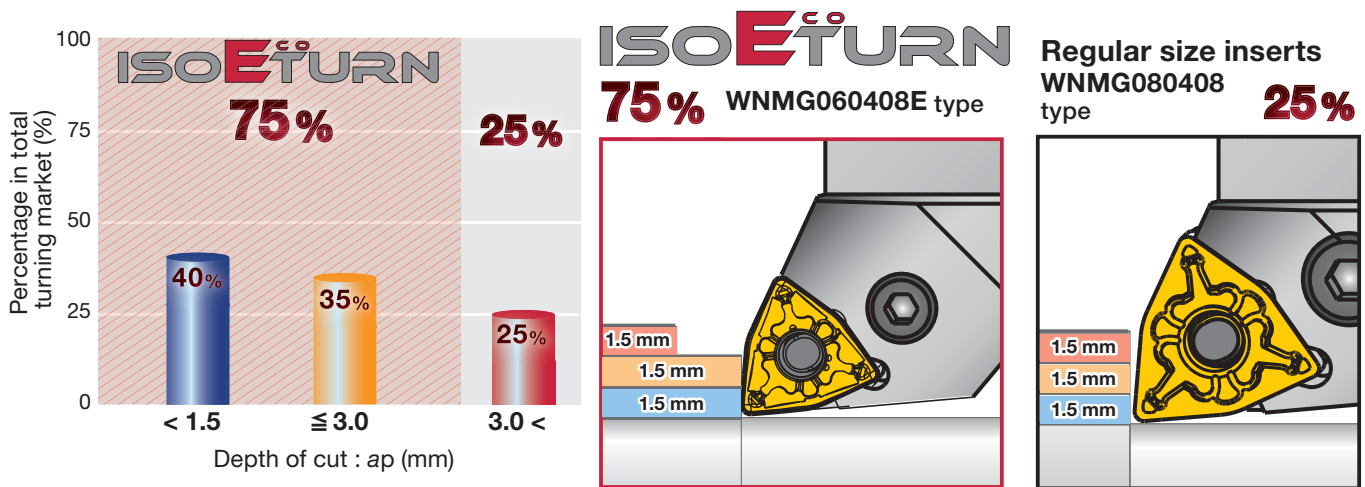

Uncompromising insert performance

- Comparison of ISO-EcoTurn and regular size inserts

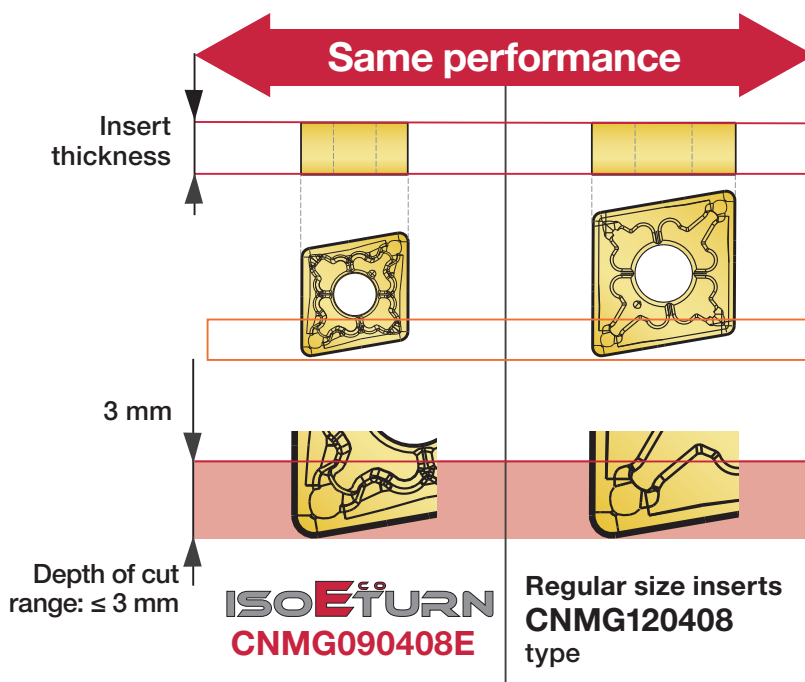

ISO-EcoTurn inserts feature the identical thickness and chipbreaker geometry as Tungaloy's regular size inserts.

These properties provide cutting performance equal to that of the regular size inserts, including chip control at a depth of cut up to 3 mm.

ISO ETURN

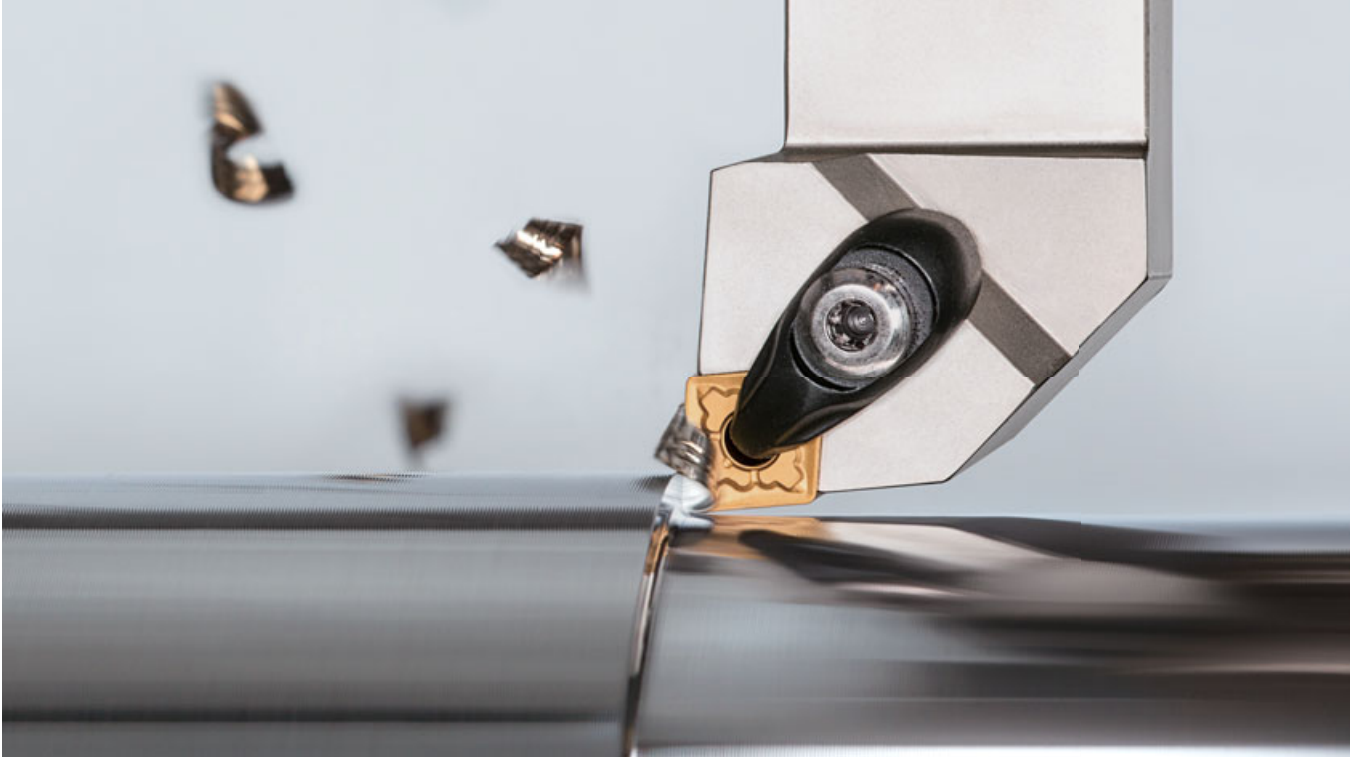

Regular size inserts



Insert Performance

Fracture resistance

-ISO-EcoTurn inserts incorporate a cutting edge geometry that maintains the same fracture resistance as regular size inserts.

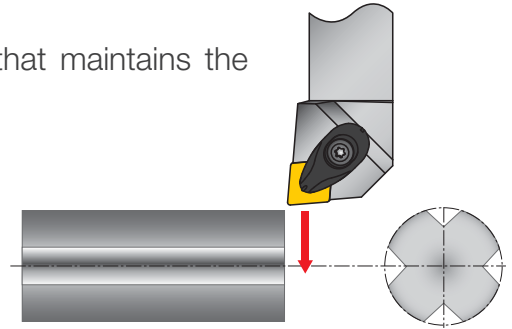
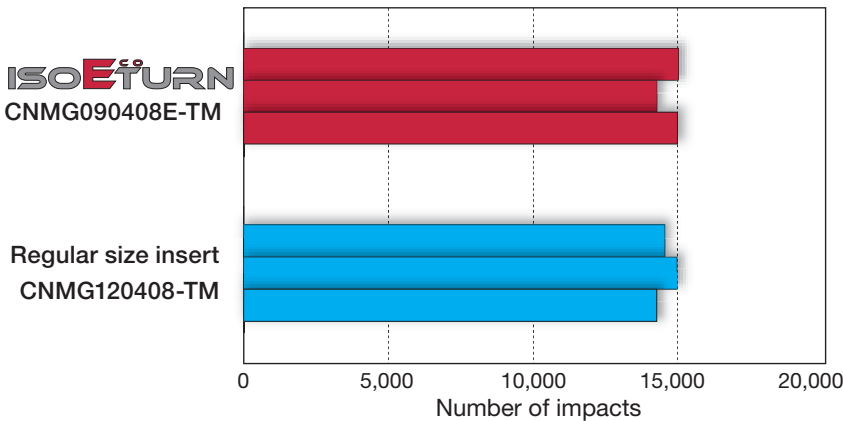

Workpiece : S45C / C45
 Cutting speed : $V_c = 150$ m/min
 Feed : $f = 0.25$ mm/rev
 Depth of cut : $a_p = 3.0$ mm
 Work process : Face turning (Interrupted)
 Coolant : Wet

Chip control

ISO-EcoTurn inserts incorporate an identical chipbreaker geometry as regular size inserts providing the same chip removal at a depth of cut up to 3 mm.

Workpiece : S45C / C45
 Cutting speed : $V_c = 200$ m/min
 Coolant : Wet

ISO ETURN
CNMG090408E-TM

Depth of cut : a_p (mm)	3.0					
	2.0					
	1.5					
	1.0					
	0.5					
Condition		0.10	0.15	0.20	0.30	0.40
		Feed : f (mm/rev)				

Regular size inserts
CNMG120408-TM

Depth of cut : a_p (mm)	3.0					
	2.0					
	1.5					
	1.0					
	0.5					
Condition		0.10	0.15	0.20	0.30	0.40
		Feed : f (mm/rev)				

GRADES & CHIPBREAKERS

T9100 SERIES (CVD)

PREMIUMTEC
TUNGALOY

- T9105** : Good wear resistance
- T9115** : Suitable for a wide range of turning applications
- T9125** : First choice for machining steel



Steel

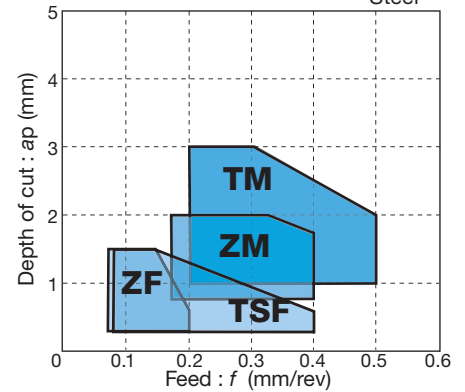

NS9530 & GT9530 (Cermet) (Coated cermet)

PREMIUMTEC
TUNGALOY

- NS9530** : Suitable for finishing to medium cutting of steel
- GT9530** : Ideal for finishing with high surface quality

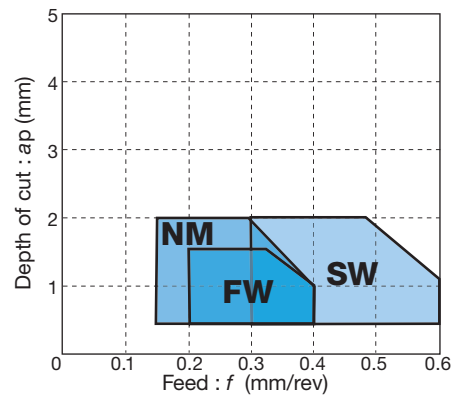

AH600 SERIES (PVD)

PREMIUMTEC
TUNGALOY

- AH630** : Good resistance to wear and fracture in machining stainless steel at low to medium cutting speed
- AH645** : High fracture resistance in machining stainless steel



Stainless

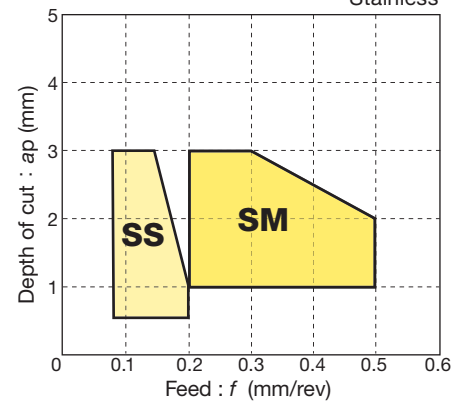

T6100 SERIES (CVD)

PREMIUMTEC
TUNGALOY

- T6120** : Good wear resistance in continuous cutting at high speed
- T6130** : High wear resistance in cutting at medium to high speed

GRADES & CHIPBREAKERS

T5100 SERIES (CVD)

PREMIUMTEC
TUNGALOY

T5115 : Stable machining in a wide range of applications from continuous to interrupted cutting

T515 (CVD)

PREMIUMTEC
TUNGALOY

T515 : Good wear resistance even in high speed machining



Cast Iron

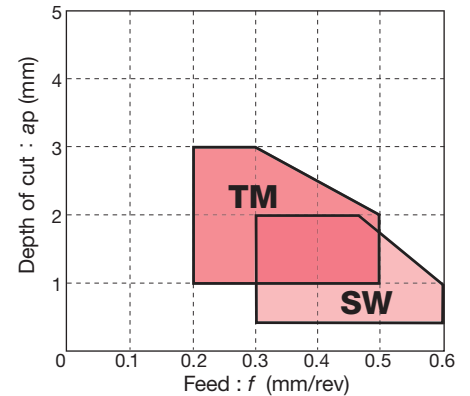

AH8000 SERIES (PVD)

PREMIUMTEC
TUNGALOY

AH8015 : Strong resistance to wear and built up edge



Stainless



Superalloys and titanium

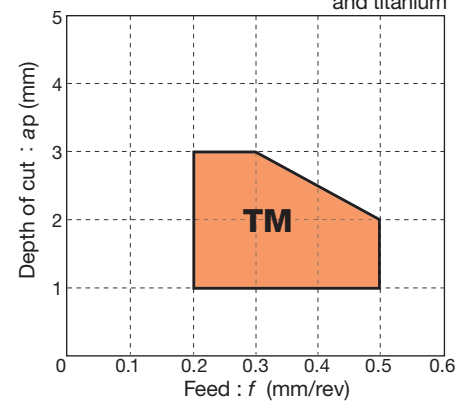

AH120 (PVD)

PREMIUMTEC
TUNGALOY

AH120 : Suitable for machining steel, stainless steel, cast iron and heat resistant alloys under general cutting conditions



Steel



Stainless











Cast Iron

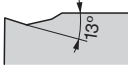
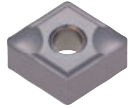

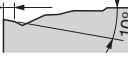
Superalloys and titanium

INSERT NEGATIVE TYPE

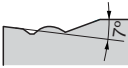

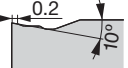
Rhombic, 80°

Application	Chipbreaker	Cat. No	Stocked grades										I.C.dia	Thick-ness	Hole dia	Corner radius		
	Appearance (Cross section)		Coated						Cermet		Coated cermet							
			T9105	T9115	T9125	T5115	AH630	AH645	NS9530		GT9530							
				ϕd	s	ϕd_1	r_ϵ											
Finishing	TSF	CNMG090404E-TSF		●	●						●		●		9.525	4.76	3.81	0.4
		*CNMG090408E-TSF		●	●						●		●		9.525	4.76	3.81	0.8
																		
	SS	CNMG090404E-SS						●	●						9.525	4.76	3.81	0.4
		*CNMG090408E-SS						●	●						9.525	4.76	3.81	0.8
																		
	ZF	*CNMG090404E-ZF		●	●										9.525	4.76	3.81	0.4
																		
																		
	FW	CNMG090404E-FW		●	●	●					●		●		9.525	4.76	3.81	0.4
	Wiper	*CNMG090408E-FW		●	●	●					●		●		9.525	4.76	3.81	0.8
																		
																		
Finishing to medium cutting	ZM	*CNMG090408E-ZM		●	●									9.525	4.76	3.81	0.8	
																		
																		
	SW	*CNMG090408E-SW		●	●	●	●							9.525	4.76	3.81	0.8	
Wiper	CNMG090412E-SW		●	●	●	●							9.525	4.76	3.81	1.2		
																		
																		

Note: Chipbreaker cross section diagrams refer to the marked (*) inserts

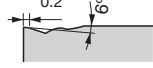

● : Line up

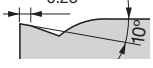
Rhombic, 80°

Application	Chipbreaker	Cat. No	Stocked grades								I.C.dia	Thick-ness	Hole dia	Corner radius
	Appearance (Cross section)		Coated											
			T9115	T9125	T6120	T6130	AH630	T515	AH120	AH8015				
Medium cutting	TM	CNMG090404E-TM	●	●	●	●	●	●	●	●	9.525	4.76	3.81	0.4
		*CNMG090408E-TM	●	●	●	●	●	●	●	●	9.525	4.76	3.81	0.8
		CNMG090412E-TM	●	●	●	●	●	●	●	●	9.525	4.76	3.81	1.2
	SM	CNMG090404E-SM			●	●	●				9.525	4.76	3.81	0.4
		*CNMG090408E-SM			●	●	●				9.525	4.76	3.81	0.8
		CNMG090412E-SM			●	●	●				9.525	4.76	3.81	1.2

Note: Chipbreaker cross section diagrams refer to the marked (*) inserts

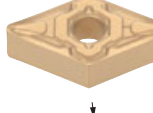
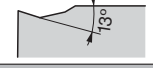
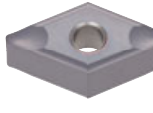

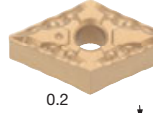
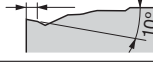





Rhombic, 55°

Application	Chipbreaker	Cat. No	Stocked grades								I.C.dia	Thick-ness	Hole dia	Corner radius	
	Appearance (Cross section)		Coated						Cermet	Coated cermet					
			T9115	T9125	T6120	T6130	AH630	AH645	NS9530	GT9530					
Finishing	TSF	DNMG110404E-TSF	●	●						●	●	9.525	4.76	3.81	0.4
		*DNMG110408E-TSF	●	●						●	●	9.525	4.76	3.81	0.8
		DNMG110412E-TSF	●	●						●	●	9.525	4.76	3.81	1.2
	SS	DNMG110404E-SS					●	●				9.525	4.76	3.81	0.4
		*DNMG110408E-SS					●	●				9.525	4.76	3.81	0.8
		ZF	*DNMG110404E-ZF	●	●							9.525	4.76	3.81	0.4
															
															

Note: Chipbreaker cross section diagrams refer to the marked (*) inserts

●: Line up

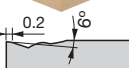

Rhombic, 55°

Application	Chipbreaker	Cat. No	Stocked grades										I.C.dia	Thick-ness	Hole dia	Corner radius	
	Appearance (Cross section)		Coated					Cermet		Coated cermet							
			T9115	T9125	T6120	T6130	AH630	AH645	NS9530		GT9530						
			ϕd	s	$\phi d1$	$r\epsilon$											
Finishing	FW	DNMG110404E-FW	●											9.525	4.76	3.81	0.4
	Wiper  	*DNMG110408E-FW	●												9.525	4.76	3.81
Finishing to medium cutting	ZM	*DNMG110408E-ZM	●	●										9.525	4.76	3.81	0.8
	 																
	SW	*DNMG110408E-SW	●											9.525	4.76	3.81	0.8
	Wiper  	DNMG110412E-SW	●											9.525	4.76	3.81	1.2
Medium cutting	TM	DNMG110404E-TM	●	●										9.525	4.76	3.81	0.4
	 	*DNMG110408E-TM	●	●										9.525	4.76	3.81	0.8
		DNMG110412E-TM	●	●										9.525	4.76	3.81	1.2
	SM	DNMG110404E-SM			●	●	●							9.525	4.76	3.81	0.4
	 	*DNMG110408E-SM			●	●	●							9.525	4.76	3.81	0.8

Note: Chipbreaker cross section diagrams refer to the marked (*) inserts

●: Line up

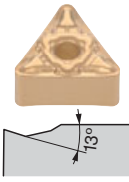

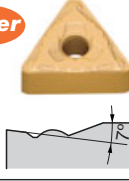
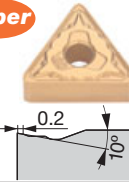
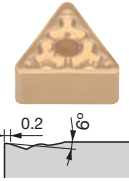
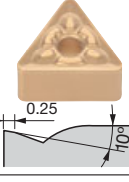
Triangular, 60°

Application	Chipbreaker	Cat. No	Stocked grades										I.C.dia	Thick-ness	Hole dia	Corner radius	
	Appearance (Cross section)		Coated						Cermet		Coated cermet						
			T9115	T9125	T6120	T6130	AH630	AH645	NS9530		GT9530						
				ϕd	s	$\phi d1$	$r\epsilon$										
Finishing	TSF	TNMG110404E-TSF	●	●						●		●		6.35	4.76	2.26	0.4
		*TNMG110408E-TSF	●	●						●		●		6.35	4.76	2.26	0.8
	SS	TNMG110404E-SS						●	●					6.35	4.76	2.26	0.4
		*TNMG110408E-SS						●	●					6.35	4.76	2.26	0.8
	FW	TNMG110404E-FW	●											6.35	4.76	2.26	0.4
		*TNMG110408E-FW	●											6.35	4.76	2.26	0.8
Finishing to medium cutting	SW	*TNMG110408E-SW	●										6.35	4.76	2.26	0.8	
		TNMG110412E-SW	●										6.35	4.76	2.26	1.2	
Medium cutting	TM	TNMG110404E-TM	●	●									6.35	4.76	2.26	0.4	
		*TNMG110408E-TM	●	●									6.35	4.76	2.26	0.8	
		TNMG110412E-TM	●	●									6.35	4.76	2.26	1.2	
	SM	TNMG110404E-SM			●	●	●						6.35	4.76	2.26	0.4	
	*TNMG110408E-SM			●	●	●						6.35	4.76	2.26	0.8		

Note: Chipbreaker cross section diagrams refer to the marked (*) inserts

●: Line up

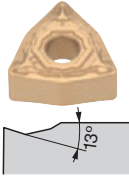
Trigon, 80°

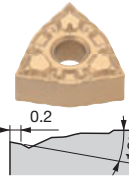
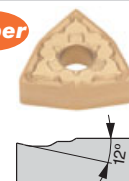
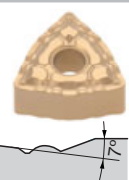
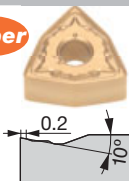
Application	Chipbreaker	Cat. No	Stocked grades										I.C.dia	Thick-ness	Hole dia	Corner radius			
	Appearance (Cross section)		Coated						Cermet		Coated cermet								
			T9105	T9115	T9125	T5115	AH630	AH645	NS9530		GT9530								
												ϕd	s	$\phi d1$	$r\epsilon$				
Finishing	TSF	WNMG060404E-TSF		●	●							●	●		9.525	4.76	3.81	0.4	
		*WNMG060408E-TSF		●	●							●	●		9.525	4.76	3.81	0.8	
		WNMG060412E-TSF		●	●							●	●		9.525	4.76	3.81	1.2	
	SS	WNMG060404E-SS						●	●						9.525	4.76	3.81	0.4	
		*WNMG060408E-SS						●	●						9.525	4.76	3.81	0.8	
		WNMG060412E-SS						●	●						9.525	4.76	3.81	1.2	
	ZF	*WNMG060404E-ZF			●	●									9.525	4.76	3.81	0.4	
																			
	FW	WNMG060404E-FW		●	●	●						●	●		9.525	4.76	3.81	0.4	
		*WNMG060408E-FW		●	●	●						●	●		9.525	4.76	3.81	0.8	
	Finishing to medium cutting	ZM	*WNMG060408E-ZM		●	●									9.525	4.76	3.81	0.8	
																			
SW		*WNMG060408E-SW		●	●	●	●							9.525	4.76	3.81	0.8		
	WNMG060412E-SW		●	●	●	●							9.525	4.76	3.81	1.2			

Note: Chipbreaker cross section diagrams refer to the marked (*) inserts

●: Line up

Trigon, 80°

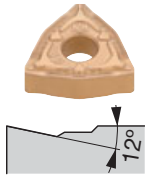
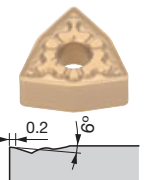
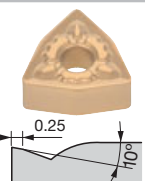
Application	Chipbreaker	Cat. No	Stocked grades										I.C.dia	Thick-ness	Hole dia	Corner radius					
	Appearance (Cross section)		Coated						Cermet		Coated cermet										
			T9115	T9125	T6120	T6130	AH630	AH645	NS9530		GT9530										
												ϕd	s	$\phi d1$	r ϵ						
Finishing to medium cutting	NM	*WNMG060412E-NM		●													9.525	4.76	3.81	1.2	
																					
Medium cutting	TM	WNMG060404E-TM	●	●													9.525	4.76	3.81	0.4	
		*WNMG060408E-TM	●	●													9.525	4.76	3.81	0.8	
		WNMG060412E-TM	●	●													9.525	4.76	3.81	1.2	
	SM	WNMG060404E-SM			●	●	●										9.525	4.76	3.81	0.4	
		*WNMG060408E-SM			●	●	●										9.525	4.76	3.81	0.8	
	WNMG060412E-SM			●	●	●										9.525	4.76	3.81	1.2		

Note: Chipbreaker cross section diagrams refer to the marked (*) inserts

● : Line up

New Rhombic, 35°

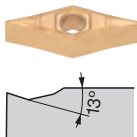
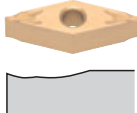
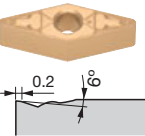
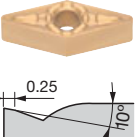
Application	Chipbreaker	Cat. No	Stocked grades										I.C.dia	Thick-ness	Hole dia	Corner radius
	Appearance (Cross section)		Coated					Cermet		Coated cermet						
			T9115	T9125	T6120	T6130	AH630	AH645	NS9530		GT9530					
												ϕd	s	$\phi d1$	r ϵ	
Finishing	TSF 	VNMG120402E-TSF	●	●							●	●	7.15	4.76	3.81	0.2
		VNMG120404E-TSF	●	●							●	●	7.15	4.76	3.81	0.4
		*VNMG120408E-TSF	●	●							●	●	7.15	4.76	3.81	0.8
	SS 	VNMG120404E-SS			●	●	●	●					7.15	4.76	3.81	0.4
	*VNMG120408E-SS			●	●	●	●					7.15	4.76	3.81	0.8	
Medium cutting	TM 	VNMG120404E-TM	●	●									7.15	4.76	3.81	0.4
		*VNMG120408E-TM	●	●									7.15	4.76	3.81	0.8
	SM 	VNMG120404E-SM			●	●	●	●					7.15	4.76	3.81	0.4
	*VNMG120408E-SM			●	●	●	●					7.15	4.76	3.81	0.8	

Note: Chipbreaker cross section diagrams refer to the marked (*) inserts

●: Line up

A complete tooling solution now available with ISO-EcoTurn

The addition of the VNMG line complements the ISO-EcoTurn series, providing a comprehensive tooling solution in every turning application.

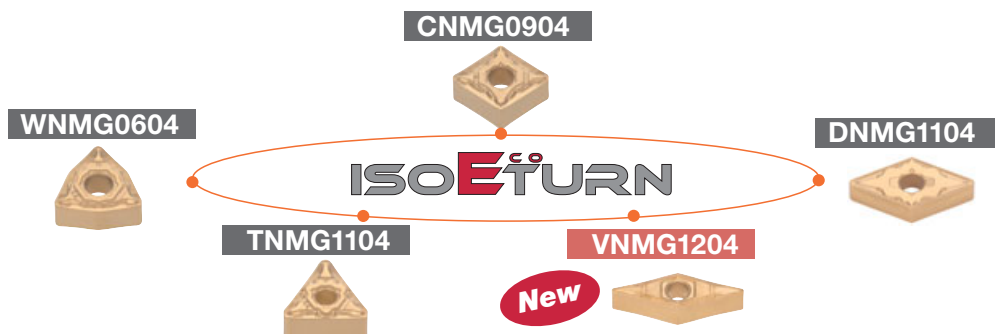

ACLNR/L-Eco

Double-clamp toolholders – 95° approach angle. For negative 80° rhombic insert.

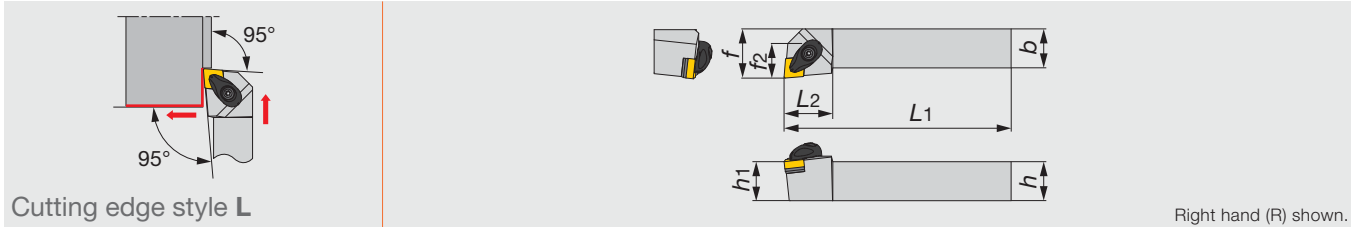

Designation	<i>h</i>	<i>b</i>	<i>L</i> ₁	<i>L</i> ₂	<i>h</i> ₁	<i>f</i>	<i>f</i> ₂	<i>r</i> _ε **	Insert	Torque*
ACLNR/L2020K0904-A	20	20	125	25	20	25	18	0.8	CN**0904...	3
ACLNR/L2525M0904-A	25	25	150	25	25	32	18	0.8	CN**0904...	3

*Torque: Recommended torque (N·m) for clamping **re: Standard corner radius

SPARE PARTS							
Designation	Clamp	Clamp screw	Spring	Spring pin	Shim	Shim screw	Wrench
ACLNR/L**0904-A	ACP3S-E	ACS-5W	BP-7	SP-2.5	ASC322	CSTB-3.5	T-15F

ADJNR/L-Eco

Double-clamp toolholders – 93° approach angle. For negative 55° rhombic insert.

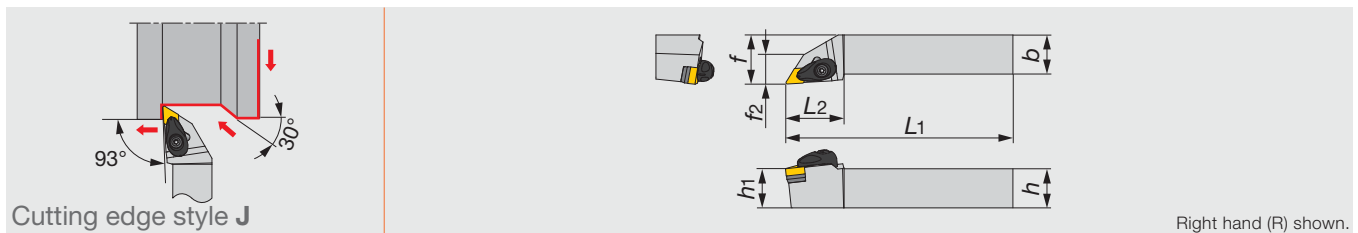

Designation	<i>h</i>	<i>b</i>	<i>L</i> ₁	<i>L</i> ₂	<i>h</i> ₁	<i>f</i>	<i>f</i> ₂	<i>r</i> _ε **	Insert	Torque*
ADJNR/L2020K1104-A	20	20	125	30	20	25	16	0.8	DN**1104...	3
ADJNR/L2525M1104-A	25	25	150	30	25	32	19	0.8	DN**1104...	3

*Torque: Recommended torque (N·m) for clamping **re: Standard corner radius

SPARE PARTS							
Designation	Clamp	Clamp screw	Spring	Spring pin	Shim	Shim screw	Wrench
ADJNR/L**1104-A	ACP3S-E	ACS-5W	BP-7	SP-2.5	ASD322	CSTB-3.5	T-15F

ADQNR/L-Eco

Double-clamp toolholders – 107.5° approach angle. For negative 55° rhombic insert.

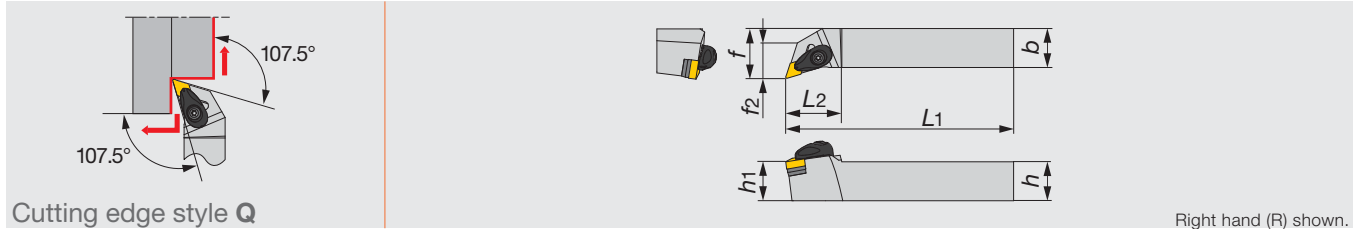

Cutting edge style Q

Right hand (R) shown.

Designation	h	b	L1	L2	h1	f	f2	r _ε **	Insert	Torque*
ADQNR/L2020K1104-A	20	20	125	30	20	25	18	0.8	DN**1104...	3
ADQNR/L2525M1104-A	25	25	150	30	25	32	20	0.8	DN**1104...	3

*Torque: Recommended torque (N·m) for clamping **re: Standard corner radius

SPARE PARTS

Designation	Clamp	Clamp screw	Spring	Spring pin	Shim	Shim screw	Wrench
ADQNR/L**1104-A	ACP3S-E	ACS-5W	BP-7	SP-2.5	ASD322	CSTB-3.5	T-15F

AWLNR/L-Eco

Double-clamp toolholders – 95° approach angle. For negative 80° trigon insert.

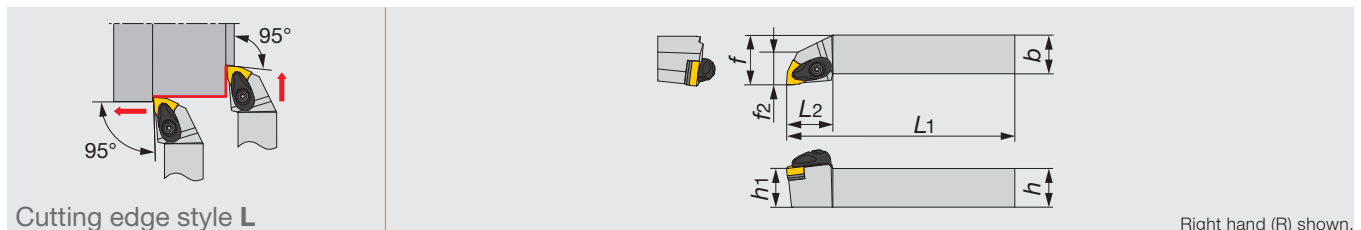

Cutting edge style L

Right hand (R) shown.

Designation	h	b	L1	L2	h1	f	f2	r _ε **	Insert	Torque*
AWLNR/L2020K0604-A	20	20	125	27	20	25	16	0.8	WN**0604...	3
AWLNR/L2525M0604-A	25	25	150	27	25	32	23	0.8	WN**0604...	3

*Torque: Recommended torque (N·m) for clamping **re: Standard corner radius

SPARE PARTS

Designation	Clamp	Clamp screw	Spring	Spring pin	Shim	Shim screw	Wrench
AWLNR/L**0604-A	ACP3S-E	ACS-5W	BP-7	SP-2.5	ASW322	CSTB-3.5	T-15F

New

AVJNR/L-Eco

Double-clamp toolholders – 93° approach angle. For negative 35° rhombic insert.

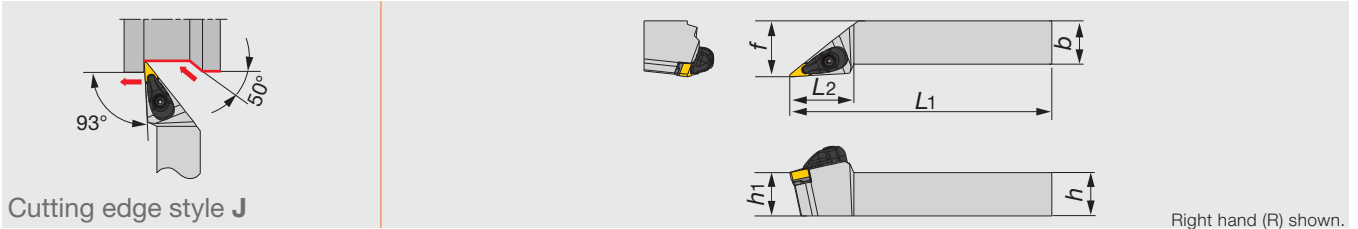

Cutting edge style J

Right hand (R) shown.

Designation	<i>h</i>	<i>b</i>	<i>L</i> ₁	<i>L</i> ₂	<i>h</i> ₁	<i>f</i>	<i>r_c</i> **	Insert	Torque*
AVJNR/L2020K1204-A	20	20	125	37	20	25	0.8	VN**1204...	3
AVJNR/L2525M1204-A	25	25	150	37	25	32	0.8	VN**1204...	3

*Torque: Recommended torque (N·m) for clamping ***r_c*: Standard corner radius

SPARE PARTS

Designation	Clamp	Clamp screw	Spring	Spring pin	Shim	Shim screw	Wrench
AVJNR/L**1204-A	ACP3L-E	ACS-5W	BP-7	SP-2.5	ASV222	CSTB-3.0	T-15F

New

AVQNR/L-Eco

Double-clamp toolholders – 117.5° approach angle. For negative 35° rhombic insert.

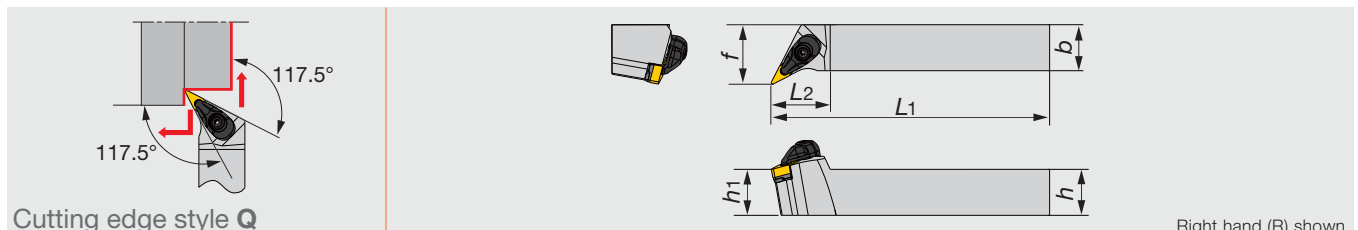

Cutting edge style Q

Right hand (R) shown.

Designation	<i>h</i>	<i>b</i>	<i>L</i> ₁	<i>L</i> ₂	<i>h</i> ₁	<i>f</i>	<i>r_c</i> **	Insert	Torque*
AVQNR/L2020K1204-A	20	20	125	32	20	25	0.8	VN**1204...	3
AVQNR/L2525M1204-A	25	25	150	32	25	32	0.8	VN**1204...	3

*Torque: Recommended torque (N·m) for clamping ***r_c*: Standard corner radius

SPARE PARTS

Designation	Clamp	Clamp screw	Spring	Spring pin	Shim	Shim screw	Wrench
AVQNR/L**1204-A	ACP3L-E	ACS-5W	BP-7	SP-2.5	ASV222	CSTB-3.0	T-15F

New

AVVNN-Eco



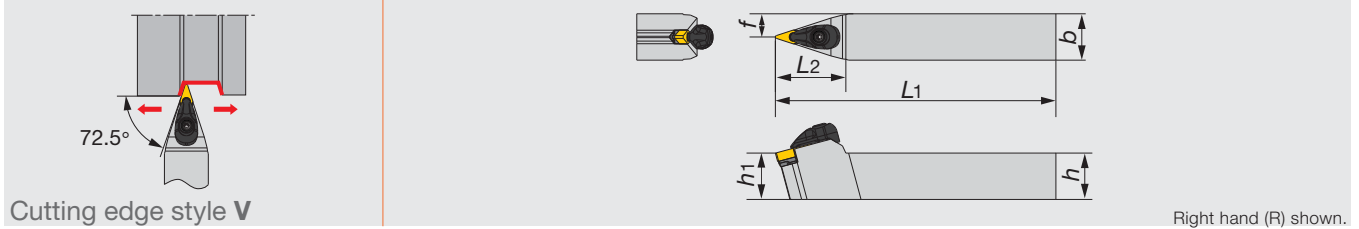



Double-clamp toolholders – 72.5° approach angle. For negative 35° rhombic insert.



Designation	<i>h</i>	<i>b</i>	<i>L</i> ₁	<i>L</i> ₂	<i>h</i> ₁	<i>f</i>	<i>r</i> _c **	Insert	Torque*
AVVNN2020K1204-A	20	20	125	38	20	10	0.8	VN**1204...	3
AVVNN2525K1204-A	25	25	150	38	25	13	0.8	VN**1204...	3

*Torque: Recommended torque (N·m) for clamping ***r*_c: Standard corner radius

SPARE PARTS

Designation							
Designation	Clamp	Clamp screw	Spring	Spring pin	Shim	Shim screw	Wrench
AVVNN**1204-A	ACP3L-E	ACS-5W	BP-7	SP-2.5	ASV222	CSTB-3.0	T-15F

PCLNR/L-Eco

Lever lock type toolholders – 95° approach angle. For negative 80° rhombic insert.

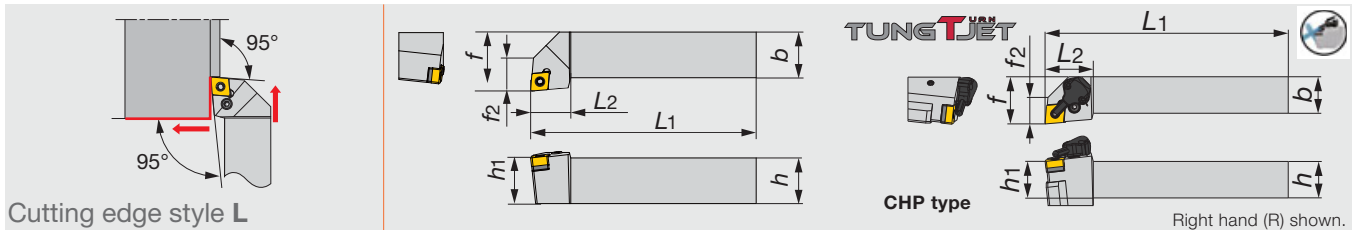

Designation	h	b	L1	L2	h1	f	f2	r _ε **	Insert	Torque*
PCLNR/L2020K0904	20	20	125	20	20	25	15	0.8	CN**0904...	2
PCLNR/L2525M0904	25	25	150	25	25	32	18	0.8	CN**0904...	2
PCLNR/L2020K0904-CHP	20	20	125	33	20	32	18	0.8	CN**0904...	2
PCLNR/L2525M0904-CHP	25	25	150	33	25	32	18	0.8	CN**0904...	2

*Torque: Recommended torque (N·m) for clamping **re: Standard corner radius

SPARE PARTS

Designation	Shim	Clamping screw	Wrench	Spring pin	Lever
PCLNR/L**0904	LSC317	LCS3	P-2.5	LSP3	LCL33
PCLNR/L**0904-CHP	LSC317	LCS3	P-2.5	LSP3	LCL33

SPARE PARTS

Designation	Coolant unit	Mounting screw	Wrench 2	O-ring	Coolant screw	Wrench 3
PCLNR/L**0904-CHP	CU-CW-CHP	SRM3	T-8F	OR6.4X0.9N	SRM4X4TL360	P-2

PDJNR/L-Eco

Lever lock type toolholders – 93° approach angle. For negative 55° rhombic insert.

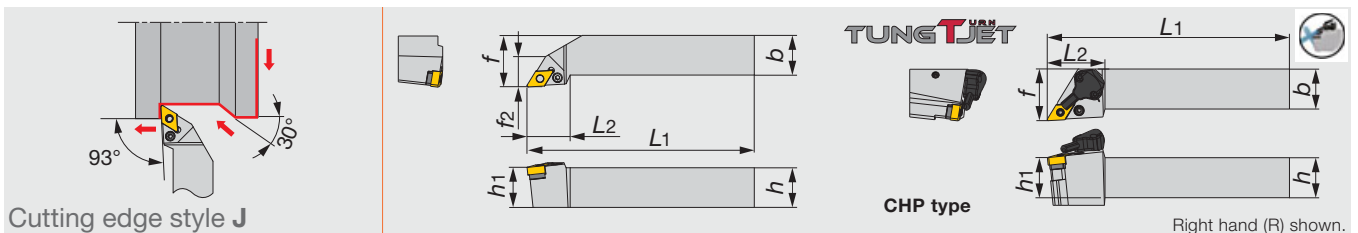

Designation	h	b	L1	L2	h1	f	f2	r _ε **	Insert	Torque*
PDJNR/L1616H1104	16	16	100	27	16	20	16	0.8	DN**1104...	2
PDJNR/L2020K1104	20	20	125	27	20	25	16	0.8	DN**1104...	2
PDJNR/L2525M1104	25	25	150	27	25	32	19	0.8	DN**1104...	2
PDJNR/L2020K1104-CHP	20	20	125	36	20	32	-	0.8	DN**1104...	2
PDJNR/L2525M1104-CHP	25	25	150	36	25	32	-	0.8	DN**1104...	2

*Torque: Recommended torque (N·m) for clamping **re: Standard corner radius

SPARE PARTS

Designation	Shim	Clamping screw	Wrench	Spring pin	Lever
PDJNR/L**1104	ELSD32	LCS3	P-2.5	LSP3	LCL33L
PDJNR/L**1104-CHP	ELSD32	LCS3	P-2.5	LSP3	LCL33L

SPARE PARTS

Designation	Coolant unit	Mounting screw	Wrench 2	O-ring	Coolant screw	Wrench 3
PDJNR/L**1104-CHP	CU-D-CHP	SRM3	T-8F	OR6.4X0.9N	SRM4X4TL360	P-2

PTFNR/L-Eco

Lever lock type toolholders for facing – 91° approach angle. For negative 60° triangular insert.

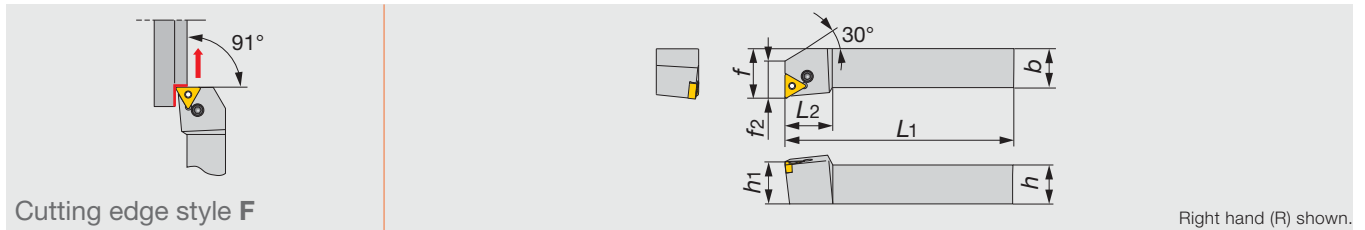

Designation	h	b	L1	L2	h1	f	f2	re**	Insert	Torque*
PTFNR/L2020K1104	20	20	125	16	20	25	16	0.8	TN**1104...	2
PTFNR/L2525M1104	25	25	150	22	25	32	20	0.8	TN**1104...	2

*Torque: Recommended torque (N·m) for clamping **re: Standard corner radius

SPARE PARTS

Designation	Clamping screw	Wrench	Lever
PTFNR/L**1104	LCS23A	P-2.5	LCL23

PTGNR/L-Eco

Lever lock type toolholders – 91° approach angle. For negative 60° triangular insert.

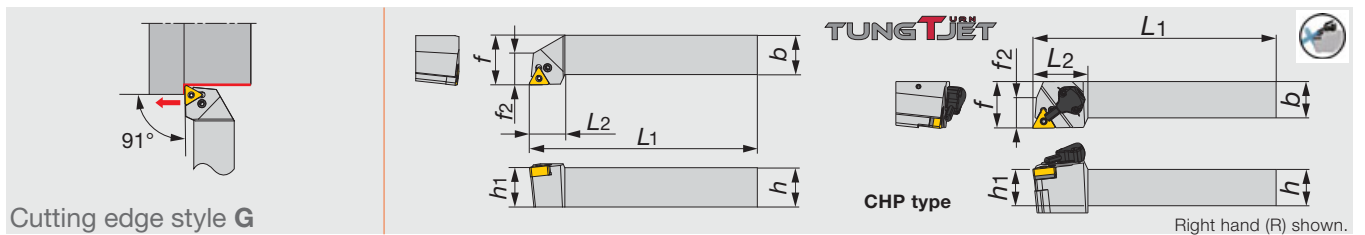

Designation	h	b	L1	L2	h1	f	f2	re**	Insert	Torque*
PTGNR/L2020K1104	20	20	125	20	20	25	15	0.8	TN**1104...	2
PTGNR/L2525M1104	25	25	150	20	25	32	22.5	0.8	TN**1104...	2
PTGNR/L2020K1104-CHP	20	20	125	38	20	32	21	0.8	TN**1104...	2
PTGNR/L2525M1104-CHP	25	25	150	38	25	32	21	0.8	TN**1104...	2

*Torque: Recommended torque (N·m) for clamping **re: Standard corner radius

SPARE PARTS

Designation	Clamping screw	Wrench	Lever
PTGNR/L**1104	LCS23A	P-2.5	LCL23
PTGNR/L**1104-CHP	LCS23A	P-2.5	LCL23

SPARE PARTS

Designation	Coolant unit	Mounting screw	Wrench 2	O-ring	Coolant screw	Wrench 3
PTGNR/L**1104-CHP	CU-CW-CHP	SRM3	T-8F	OR6.4X0.9N	SRM4X4TL360	P-2

PTJNR/L-Eco

Lever lock type toolholders – 93° approach angle. For negative 60° triangular insert.

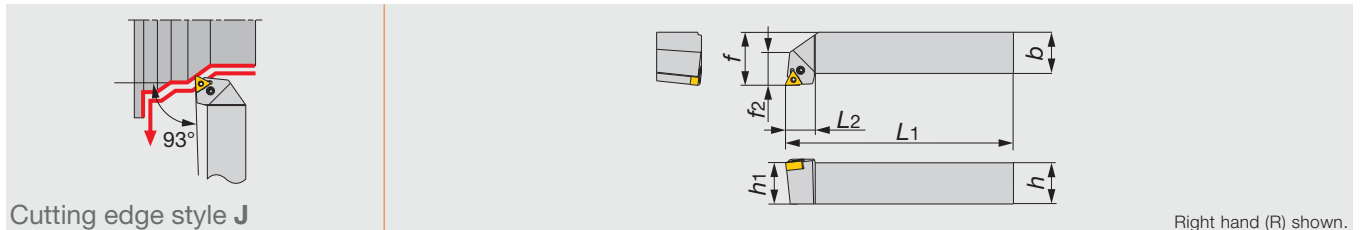

Designation	h	b	L1	L2	h1	f	f2	r _ε **	Insert	Torque*
PTJNR/L2525M1104	25	25	150	18	25	32	20	0.8	TN**1104...	2

*Torque: Recommended torque (N·m) for clamping **re: Standard corner radius

SPARE PARTS

Designation	Clamping screw	Wrench	Lever
PTJNR/L2525M1104	LCS23A	P-2.5	LCL23

PWLNR/L-Eco

Lever lock type toolholders – 95° approach angle. For negative 80° trigon insert.

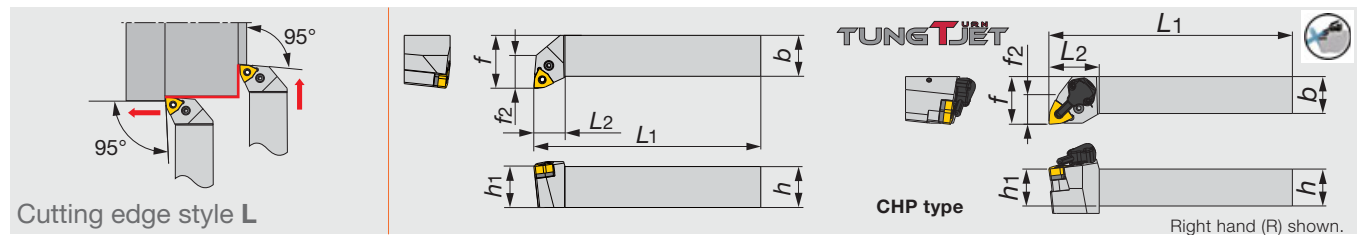

Designation	h	b	L1	L2	h1	f	f2	r _ε **	Insert	Torque*
PWLNR/L2020K0604	20	20	125	15	20	25	18	0.8	WN**0604...	2
PWLNR/L2525M0604	25	25	150	19	25	32	20	0.8	WN**0604...	2
PWLNR/L2020K0604-CHP	20	20	125	34	20	32	20	0.8	WN**0604...	2
PWLNR/L2525M0604-CHP	25	25	150	34	25	32	20	0.8	WN**0604...	2

*Torque: Recommended torque (N·m) for clamping **re: Standard corner radius

SPARE PARTS

Designation	Shim	Clamping screw	Wrench	Spring pin	Lever
PWLNR/L**0604	LSW312	LCS3	P-2.5	LSP3	LCL3
PWLNR/L**0604-CHP	LSW312	LCS3	P-2.5	LSP3	LCL3

SPARE PARTS

Designation	Coolant unit	Mounting screw	Wrench 2	O-ring	Coolant screw	Wrench 3
PWLNR/L**0604-CHP	CU-CW-CHP	SRM3	T-8F	OR6.4X0.9N	SRM4X4TL360	P-2

New

PVJNR/L-Eco

Lever lock type toolholders – 93° approach angle. For negative 35° rhombic insert.

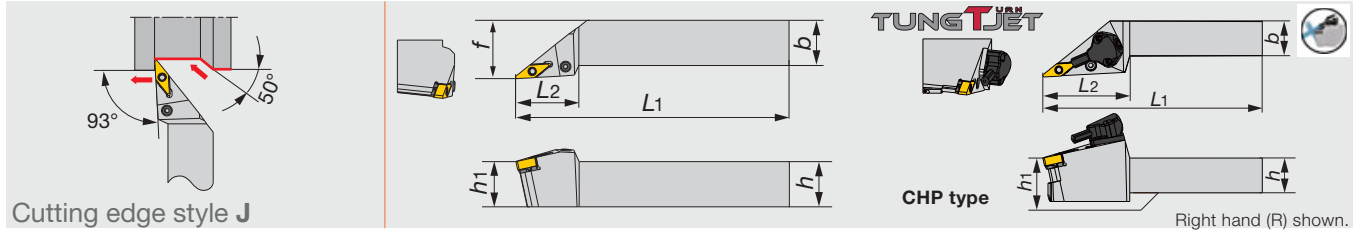

Designation	<i>h</i>	<i>b</i>	<i>L1</i>	<i>L2</i>	<i>h1</i>	<i>f</i>	<i>f2</i>	<i>r_c**</i>	Insert	Torque*
PVJNR/L2020K1204	20	20	125	35	20	25	-	0.8	VN**1204...	2
PVJNR/L2525M1204	25	25	150	35	25	32	-	0.8	VN**1204...	2
PVJNR/L2020K1204-CHP	20	20	125	50	25	32	-	0.8	VN**1204...	2
PVJNR/L2525M1204-CHP	25	25	150	50	25	32	-	0.8	VN**1204...	2

*Torque: Recommended torque (N·m) for clamping ***r_c*: Standard corner radius

SPARE PARTS

Designation	Shim	Clamping screw	Wrench	Spring pin	Lever
PVJNR/L**1204	LSV212	LCS3V	P-2.5	LSP3	LCL3V
PVJNR/L**1204-CHP	LSV212	LCS3V	P-2.5	LSP3	LCL3V

SPARE PARTS

Designation	Coolant unit	Mounting screw	Wrench 2	O-ring	Coolant screw	Wrench
PVJNR/L**1204-CHP	CU-V-CHP	SRM3	T-8F	OR6.4X0.9N	SRM4X4TL360	P-2

New



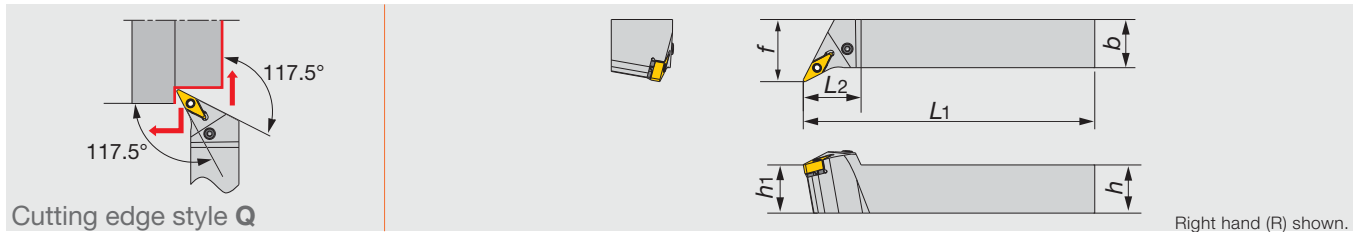

PVQNR/L-Eco

Lever lock type toolholder – 117.5° approach angle. For negative 35° rhombic insert.



Designation	<i>h</i>	<i>b</i>	<i>L</i> ₁	<i>L</i> ₂	<i>h</i> ₁	<i>f</i>	<i>r</i> _ε **	Insert	Torque*
PVQNR/L2020K1204	20	20	125	30	20	25	0.8	VN**1204...	2
PVQNR/L2525M1204	25	25	150	30	25	32	0.8	VN**1204...	2

*Torque: Recommended torque (N·m) for clamping ***r*_ε: Standard corner radius

SPARE PARTS					
Designation	Shim	Clamping screw	Wrench	Spring pin	Lever
PVQNR/L**1204	LSV212	LCS3V	P-2.5	LSP3	LCL3V

New



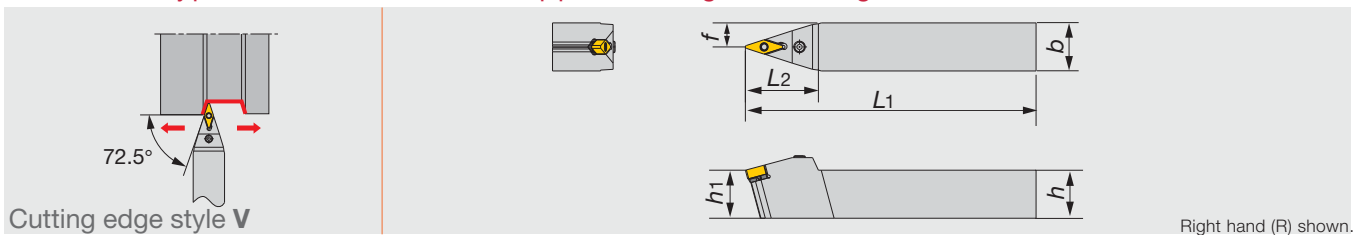

PVVNN-Eco

Lever lock type toolholders – 72.5° approach angle. For negative 35° rhombic insert.



Designation	<i>h</i>	<i>b</i>	<i>L</i> ₁	<i>L</i> ₂	<i>h</i> ₁	<i>f</i>	<i>r</i> _ε **	Insert	Torque*
PVVNN2020K1204	20	20	125	38	20	10	0.8	VN**1204...	2
PVVNN2525M1204	25	25	150	38	25	12.5	0.8	VN**1204...	2

*Torque: Recommended torque (N·m) for clamping ***r*_ε: Standard corner radius

SPARE PARTS					
Designation	Shim	Clamping screw	Wrench	Spring pin	Lever
PVVNN**1204	LSV212	LCS3V	P-2.5	LSP3	LCL3V

A-ACLNR/L-Eco

Double-clamp boring bars. For negative 80° rhombic insert.

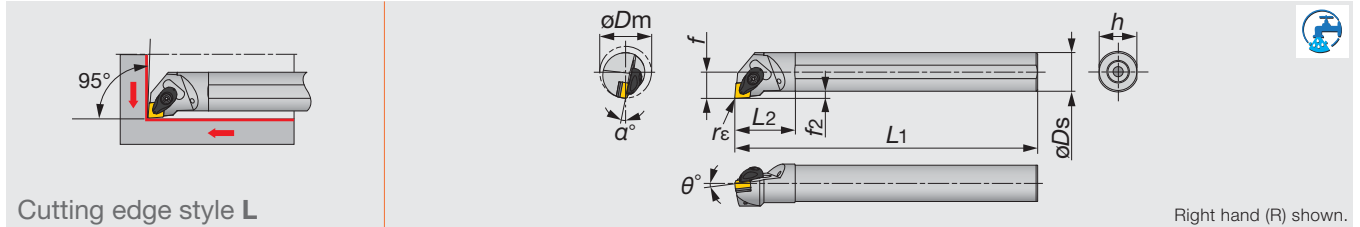

Cutting edge style L

Right hand (R) shown.

Designation	Material	ϕD_m	ϕD_s	f	L_1	L_2	h	f_2	θ°	α°	r_ϵ^{**}	Insert	Torque*
A25R-ACLNR/L0904-D320	Steel	32	25	17	200	45	23	4.5	-6	-13	0.8	CN**0904...	3
A32S-ACLNR/L0904-D400	Steel	40	32	22	250	50	30	6	-6	-10	0.8	CN**0904...	3

*Torque: Recommended torque (N·m) for clamping **re: Standard corner radius

SPARE PARTS

Designation	Clamp	Clamp screw	Spring	Spring pin	Shim	Shim screw	Wrench
A**-ACLNR/L0904...	ACP3S-E	ACS-5W	BP-7	SP-2.5	ASC322	CSTB-3.5	T-15F

A-ADUNR/L-Eco

Double-clamp boring bars. For negative 55° rhombic insert.

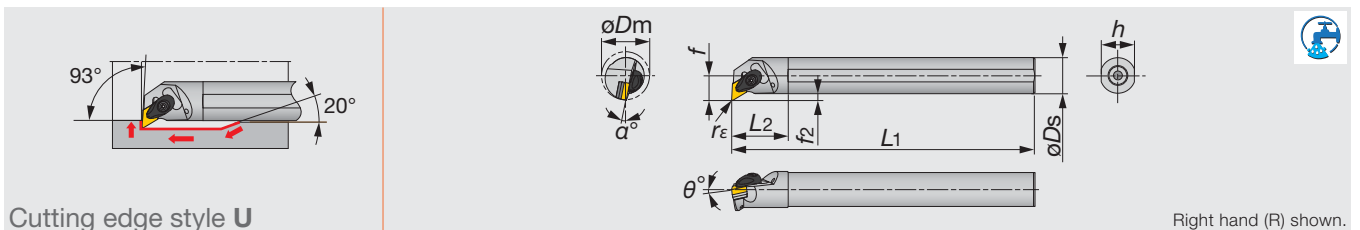

Cutting edge style U

Right hand (R) shown.

Designation	Material	ϕD_m	ϕD_s	f	L_1	L_2	h	f_2	θ°	α°	r_ϵ^{**}	Insert	Torque*
A25R-ADUNR/L1104-D320	Steel	32	25	17	200	45	23	4.5	-6	-13	0.8	DN**1104...	3
A32S-ADUNR/L1104-D400	Steel	40	32	22	250	50	30	6	-6	-11	0.8	DN**1104...	3

*Torque: Recommended torque (N·m) for clamping **re: Standard corner radius

SPARE PARTS

Designation	Clamp	Clamp screw	Spring	Spring pin	Shim	Shim screw	Wrench
A**-ADUNR/L1104...	ACP3S-E	ACS-5W	BP-7	SP-2.5	ASD322	CSTB-3.5	T-15F

A-AWLNR/L-Eco

Double-clamp boring bars. For negative 80° trigon insert.

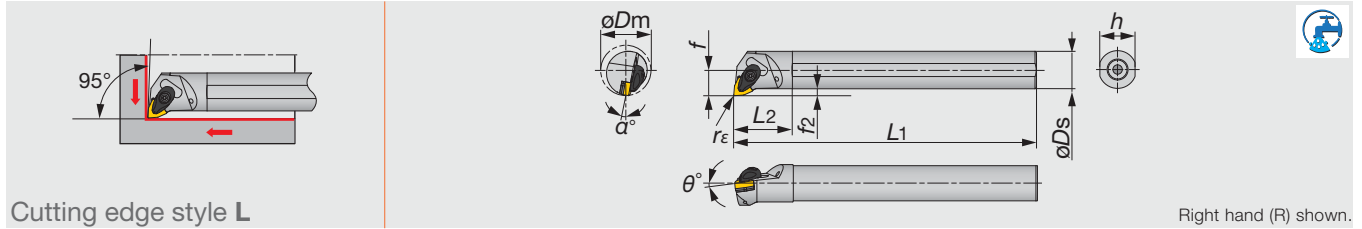

Cutting edge style L

Right hand (R) shown.

Designation	Material	ϕD_m	ϕD_s	f	L_1	L_2	h	f_2	θ°	α°	r_{ϵ}^{**}	Insert	Torque*
A25R-AWLNR/L0604-D320	Steel	32	25	17	200	45	23	4.5	-6	-13	0.8	WN**0604...	3
A32S-AWLNR/L0604-D400	Steel	40	32	22	250	50	30	6	-6	-10	0.8	WN**0604...	3

*Torque: Recommended torque (N·m) for clamping **re: Standard corner radius

SPARE PARTS

Designation	Clamp	Clamp screw	Spring	Spring pin	Shim	Shim screw	Wrench
A**-AWLNR/L0604...	ACP3S-E	ACS-5W	BP-7	SP-2.5	ASW322	CSTB-3.5	T-15F

A-PCLNR/L-Eco

Lever lock type boring bars. For negative 80° rhombic insert.

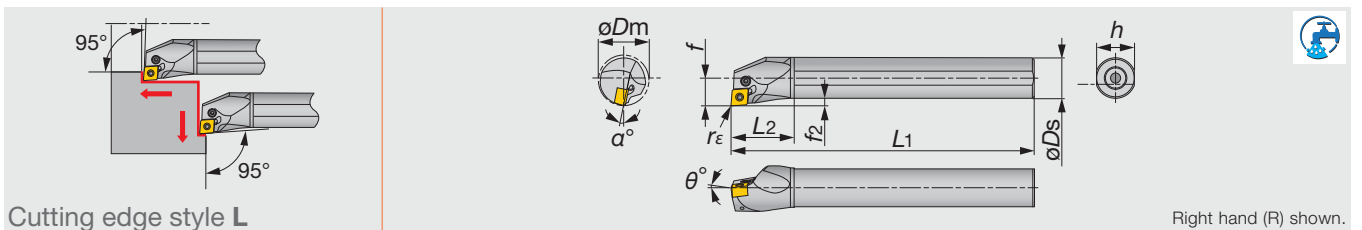

Cutting edge style L

Right hand (R) shown.

Designation	Material	ϕD_m	ϕD_s	f	L_1	L_2	h	f_2	θ°	α°	r_{ϵ}^{**}	Insert	Torque*
A16M-PCLNR/L0904-D200	Steel	20	16	11	150	32	15	3	-6	-16	0.8	CN**0904...	1.7
A20Q-PCLNR/L0904-D250	Steel	25	20	13	180	36	18	3	-6	-12	0.8	CN**0904...	1.7

*Torque: Recommended torque (N·m) for clamping **re: Standard corner radius

SPARE PARTS

Designation	Clamping screw	Wrench	Lever	Oil supply attachment	Coolant screw
A16M-PCLNR/L0904-D200	LCS33	P-2F	LCL33N	-	SSHM3-4
A20Q-PCLNR/L0904-D250	LCS33	P-2F	LCL33N	EA20	SSHM3-4

A-PDUNR/L-Eco

Lever lock type boring bars. For negative 55° rhombic insert.

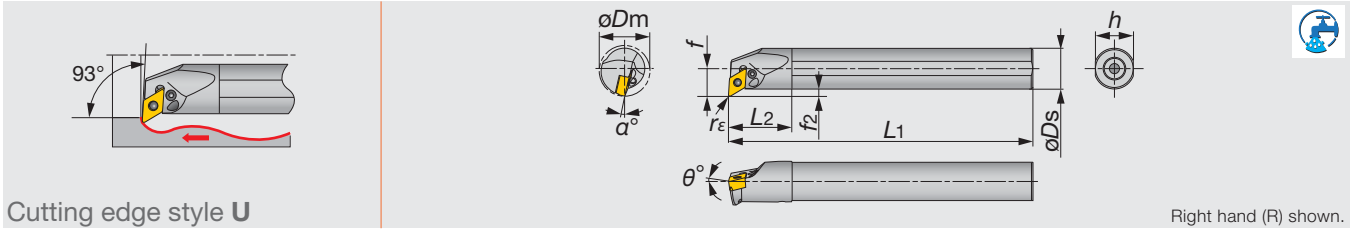

Cutting edge style U

Right hand (R) shown.

Designation	Material	ϕD_m	ϕD_s	f	L_1	L_2	h	f_2	θ°	α°	r_{ϵ}^{**}	Insert	Torque*
A20Q-PDUNR/L1104-D250	Steel	25	20	13	180	36	18	3	-6	-14	0.8	DN**1104...	1.7

*Torque: Recommended torque (N·m) for clamping ** r_{ϵ} : Standard corner radius

When using a right or left hand insert, the right hand insert (R) is used for the left hand toolholders (PDUNL ** type), and the left hand insert (L) is used for the right hand toolholders (PDUNR ** type).

SPARE PARTS

Designation	Clamping screw	Wrench	Lever	Oil supply attachment	Coolant screw
A20Q-PDUNR/L1104-D250	LCS22A	P-2F	LCL33NL	EA20	SSH2.5-3

A-PTFNR/L-Eco

Lever lock type boring bars. For negative 60° triangular insert.

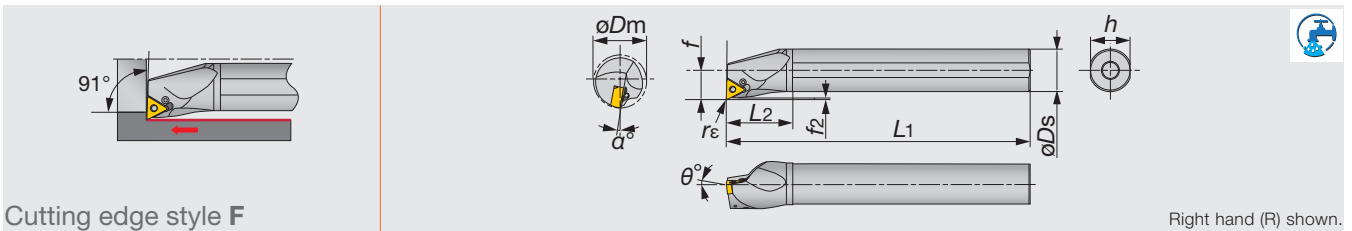

Cutting edge style F

Right hand (R) shown.

Designation	Material	ϕD_m	ϕD_s	f	L_1	L_2	h	f_2	θ°	α°	r_{ϵ}^{**}	Insert	Torque*
A25R-PTFNR/L1104-D320	Steel	32	25	17	200	45	23	1.31	-6	-12	0.8	TN**1104...	2
A32S-PTFNR/L1104-D400	Steel	40	32	22	250	50	30	1.25	-6	-10	0.8	TN**1104...	2

*Torque: Recommended torque (N·m) for clamping ** r_{ϵ} : Standard corner radius

SPARE PARTS

Designation	Clamping screw	Wrench	Lever
A**-PTFNR/L1104...	LCS23A	P-2.5	LCL23

A-PTUNR/L-Eco

Lever lock type boring bars. For negative 60° triangular insert.

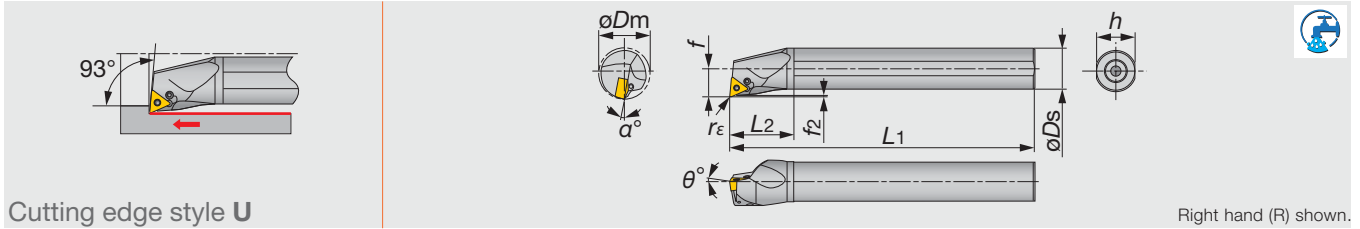

Cutting edge style U

Right hand (R) shown.

Designation	Material	ϕD_m	ϕD_s	f	L_1	L_2	h	f_2	θ°	α°	$r_{e^{**}}$	Insert	Torque*
A25R-PTUNR/L1104-D320	Steel	32	25	17	200	45	23	1.22	-6	-12	0.8	TN**1104...	2
A32S-PTUNR/L1104-D400	Steel	40	32	22	250	50	30	1.16	-6	-10	0.8	TN**1104...	2

*Torque: Recommended torque (N·m) for clamping ** r_e : Standard corner radius

SPARE PARTS

Designation	Clamping screw	Wrench	Lever	Oil supply attachment	Coolant screw
A**-PTUNR/L1104...	LCS23A	P-2.5	LCL23	EA-25	SSHM4-5

A-PWLNR/L-Eco

Lever lock type boring bars. For negative 80° trigon insert.

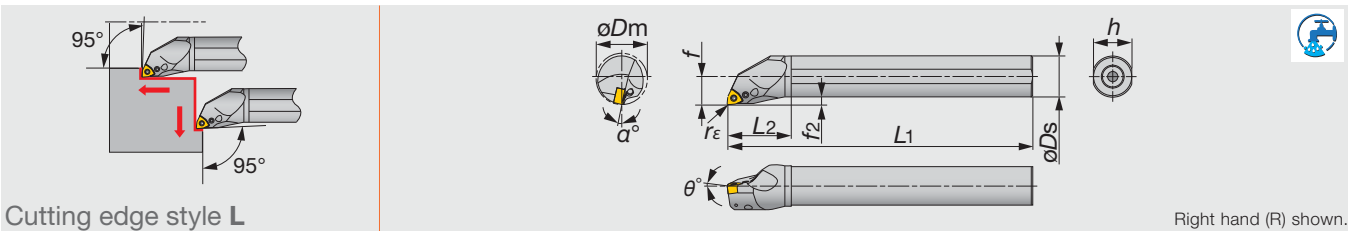

Cutting edge style L

Right hand (R) shown.

Designation	Material	ϕD_m	ϕD_s	f	L_1	L_2	h	f_2	θ°	α°	$r_{e^{**}}$	Insert	Torque*
A16M-PWLNR/L0604-D200	Steel	20	16	11	150	32	15	3	-8	-17	0.8	WN**0604...	1.7
A20Q-PWLNR/L0604-D250	Steel	25	20	13	180	36	18	3	-6	-14	0.8	WN**0604...	1.7

*Torque: Recommended torque (N·m) for clamping ** r_e : Standard corner radius

SPARE PARTS

Designation	Clamping screw	Wrench	Lever	Oil supply attachment	Coolant screw
A16M-PWLNR/L0604-D200	LCS33	P-2F	LCL33N	-	SSHM3-4
A20Q-PWLNR/L0604-D250	LCS33	P-2F	LCL33N	EA20	SSHM3-4

New

A-PVUNR/L

Lever lock type boring bars. For negative 35° rhombic insert.

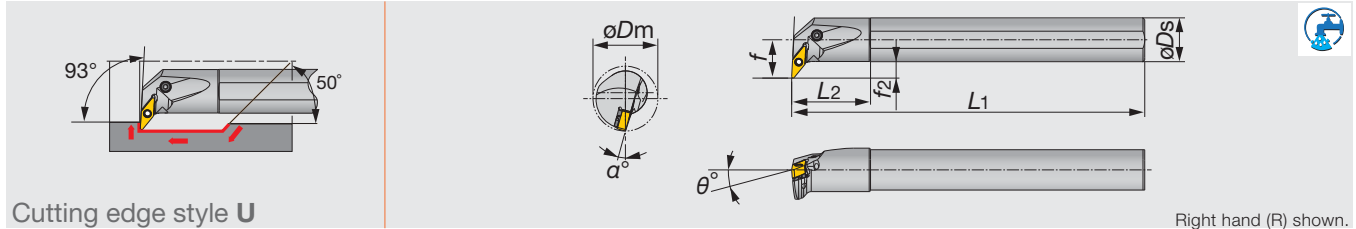

Cutting edge style U

Right hand (R) shown.

Designation	Material	ϕD_m	ϕD_s	f	L_1	L_2	h	f_2	θ°	α°	r_c^{**}	Insert	Torque*
A25R-PVUNR/L1204-D320	Steel	32	25	18	200	45	23	5.0	-5°	-15°	0.8	VN**1204...	3
A25R-PVUNR/L1204-D370	Steel	37	25	22	200	45	23	8.0	-4°	-15°	0.8	VN**1204...	3
A32S-PVUNR/L1204-D400	Steel	40	32	22	250	50	30	5.5	-6°	-12°	0.8	VN**1204...	3

*Torque: Recommended torque (N·m) for clamping ** r_c : Standard corner radius

SPARE PARTS

Designation	Clamping screw	Wrench	Lever	Shim	Spring pin	Oil supply attachment	Coolant screw
A25R-PVUNR/L1204-D320	LCS3V	P-2.5	LCL3V	LSV212	LSP3	EA-25	SSHM4-5
A25R-PVUNR/L1204-D370	LCS3V	P-2.5	LCL3V	LSV212	LSP3	EA-25	SSHM4-5
A32S-PVUNR/L1204-D400	LCS3V	P-2.5	LCL3V	LSV212	LSP3	EA-32	SSHM4-5

Economical sized insert bring benefits in small diameter ID Turning

- The new VNMG1204 insert combined with a P-type holder can turn and profile an inner diameter as small as $\phi 32$ mm.

A25R-PVUNR/L1204-D320

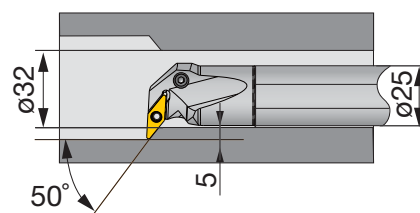
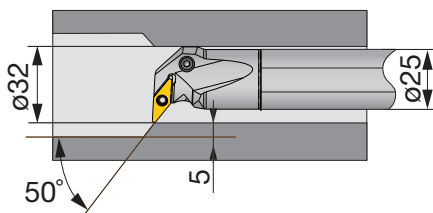

- ISO-EcoTurn also offers a holder line for a minimum working diameter of $\phi 37$ mm with VNMG1204 insert. This holder makes an excellent alternative to a standard holder with VNMG1604 insert, whose minimum working diameter is also $\phi 37$ mm.

A25R-PVUNR/L1204-D370

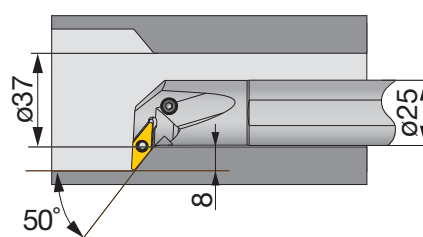
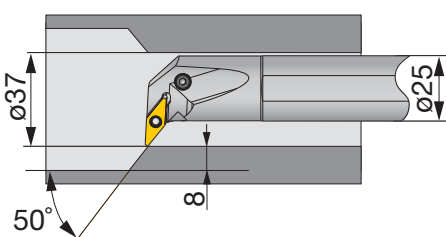

C-ACLNR/L

Turning A double-clamp toolholder with 95° approach angle. For negative 80° rhombic insert.

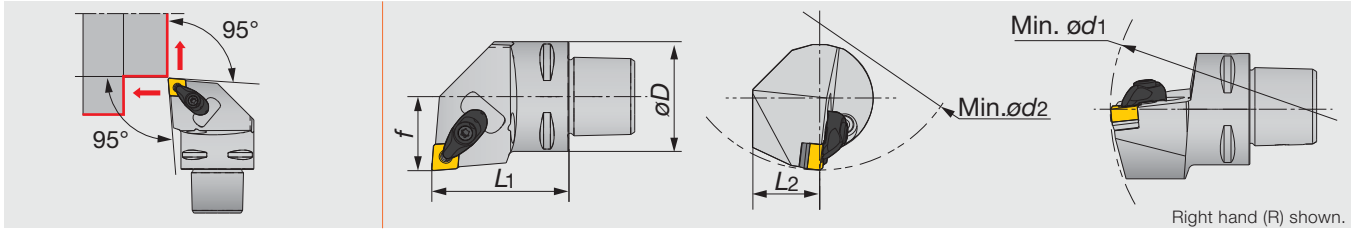

Designation	øD	L1	L2	f	ød1	ød2	rε**	Insert
C4ACLNR/L27050-0904N	40	50	25	27	140	110	0.8	CN**0904...
C6ACLNR/L45065-0904N	63	65	35	45	190	110	0.8	CN**0904...

Applicable for 7 MPa pressure coolant.

SPARE PARTS

Designation	Clamp	Clamping screw	Coolant parts	Shim	Shim screw	Spring	Spring 1	Wrench	Wrench 1
C*ACLNR/L**0904N	ACP3S-E	ACS-5W	SATZ-M10X1-M5	ASC322	CSTB-3.5	BP-7	SP-2.5	-	T-15F

C-ACMNN

Turning A double-clamp toolholder with 95° approach angle. For negative 80° rhombic insert.

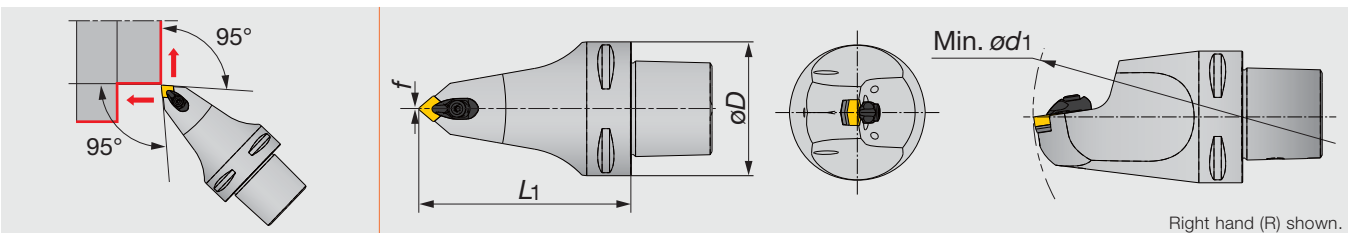

Designation	øD	L1	L2	f	ød1	ød2	rε**	Insert
C6ACMNN00100-0904N	63	100	-	0	110	-	0.8	CN**0904...
C6ACMNN00140-0904N	63	140	-	0	110	-	0.8	CN**0904...

Applicable for 7 MPa pressure coolant.

SPARE PARTS

Designation	Clamp	Clamping screw	Coolant parts	Shim	Shim screw	Spring	Spring 1	Wrench	Wrench 1
C6ACMNN**0904N	ACP3S-E	ACS-5W	-	ASC322	CSTB-3.5	BP-7	SP-2.5	-	T-15F

C-ADJNR/L

Turning A double-clamp toolholder with 93° approach angle. For negative 55° rhombic insert.

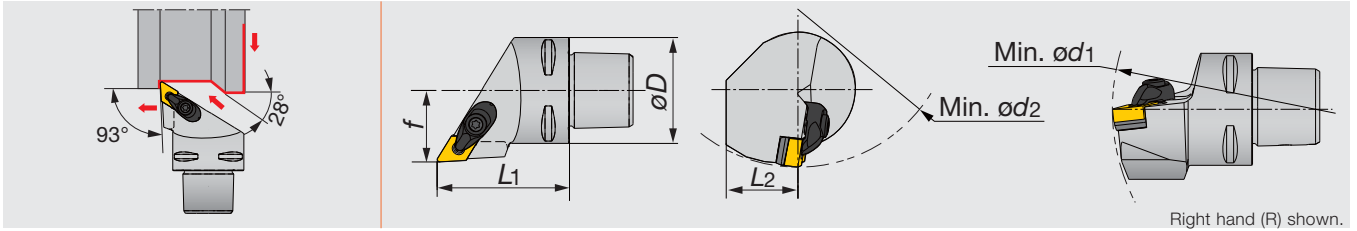

Designation	øD	L1	L2	f	ød1	ød2	rε**	Insert
C4ADJNR/L27050-1104N	40	50	25	27	145	110	0.8	DN**1104...
C6ADJNR/L45065-1104N	63	65	35	45	190	119	0.8	DN**1104...

Applicable for 7 MPa pressure coolant.

SPARE PARTS

Designation	Clamp	Clamping screw	Coolant parts	Shim	Shim screw	Spring	Spring 1	Wrench	Wrench 1
C*ADJNR/L**1104N	ACP3S-E	ACS-5W	SATZ-M10X1-M5	ASD322	CSTB-3.5	BP-7	SP-2.5	-	T-15F

C-AWLNR/L

Turning A double-clamp toolholder with 95° approach angle. For negative 80° trigon inserts.

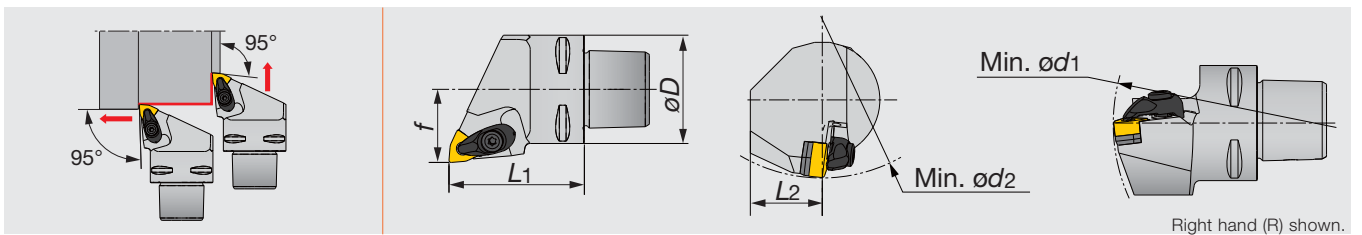

Designation	øD	L1	L2	f	ød1	ød2	rε**	Insert
C4AWLNR/L27050-0604N	40	50	25	27	140	110	0.8	WN**0604...

Applicable for 7 MPa pressure coolant.

SPARE PARTS

Designation	Clamp	Clamping screw	Coolant parts	Shim	Shim screw	Spring	Spring 1	Wrench	Wrench 1
C4AWLNR/L27050-0604N	ACP3S-E	ACS-5W	-	ASW322	CSTB-3.5	BP-7	SP-2.5	-	T-15F

New

C-AVJNR/L

Turning a double-clamp toolholder with 93° approach angle. For negative 35° rhombic insert.

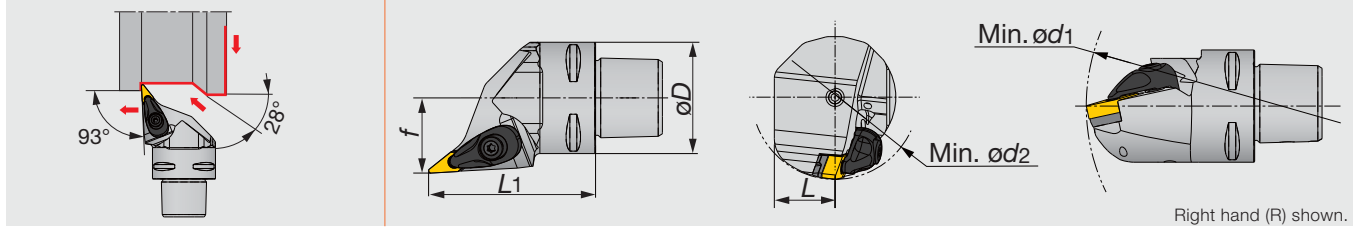

Designation	øD	L1	L2	f	ød1	ød2	rε**	Insert
C4AVJNR/L27060-1204N	40	60	20	27	140	55	0.8	VN**1204...
C6AVJNR/L45065-1204N	63	65	31.5	45	190	81	0.8	VN**1204...

Applicable for 7 MPa pressure coolant.

SPARE PARTS

Designation	Clamp	Clamping screw	Coolant parts	Shim	Shim screw	Spring	Spring 1	Wrench	Wrench 1
C4AVJNR/L27060-1204N	ACP3L-E	ACS-5W	-	ASV222	CSTB-3	BP-7	SP-2.5	T-9F	T-15F
C6AVJNR/L45065-1204N	ACP3L-E	ACS-5W	SATZ-M10X1-M5	ASV222	CSTB-3	BP-7	SP-2.5	T-9F	T-15F

C-PTJNR/L

Lever lock type toolholder with 93° approach angle. For negative 60° triangular insert.

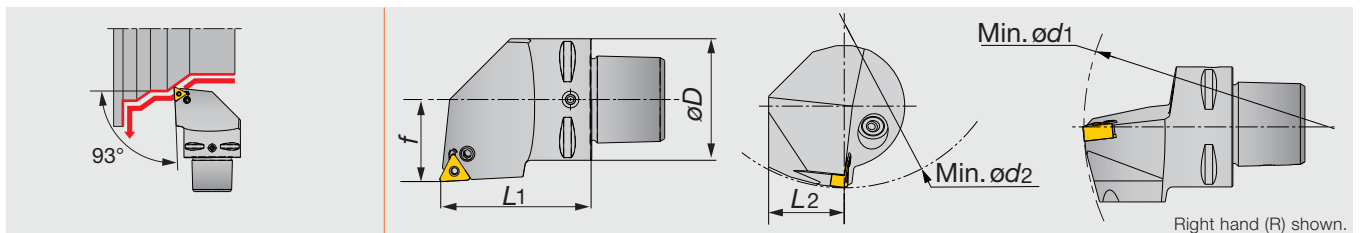

Designation	øD	L1	L2	f	ød1	ød2	rε**	Insert
C4PTJNR/L27050-1104N	40	50	25	27	140	110	0.8	TN**1104...

Applicable for 7 MPa pressure coolant.

SPARE PARTS

Designation	Clamping screw	Lever	Wrench 1
C4PTJNR/L27050-1104N	LCS23A	LCL23	P-2.5

C-PCLNR/L-CHP

Lever lock type toolholder with 95° approach angle. For negative 80° rhombic insert.

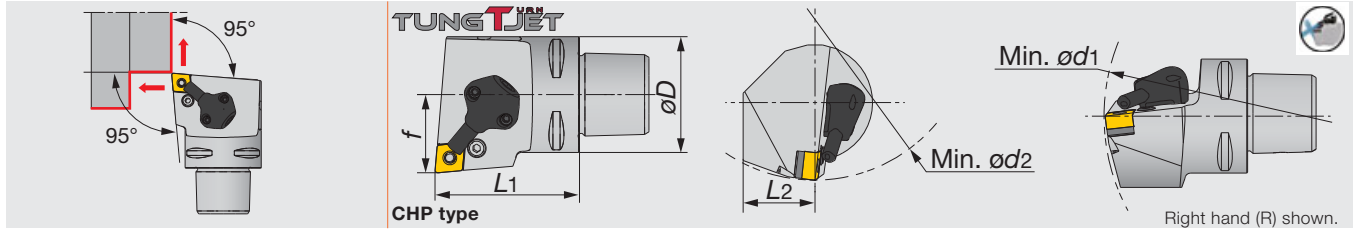

Designation	øD	L1	L2	f	ød1	ød2	rε**	Insert
C4PCLNR/L27050-0904-CHP	40	50	25	27	140	110	0.8	CN**0904...
C6PCLNR/L45065-0904-CHP	63	65	35	45	190	110	0.8	CN**0904...

Applicable for 14 MPa pressure coolant

SPARE PARTS						SPARE PARTS				
Designation	Shim	Clamping screw	Spring pin	Lever	Wrench 1	Designation	Coolant unit	Mounting screw	Wrench 2	O-ring
C*PCLNR/L**-0904-CHP	LSC317	LCS3	LSP3	LCL33	P-2.5	C*PCLNR/L**-0904-CHP	CU-CW-CHP	SRM3	T-8F	OR6.4X0.9N

C-PDJNR/L-CHP

Lever lock type toolholder with 93° approach angle. For negative 55° rhombic insert.

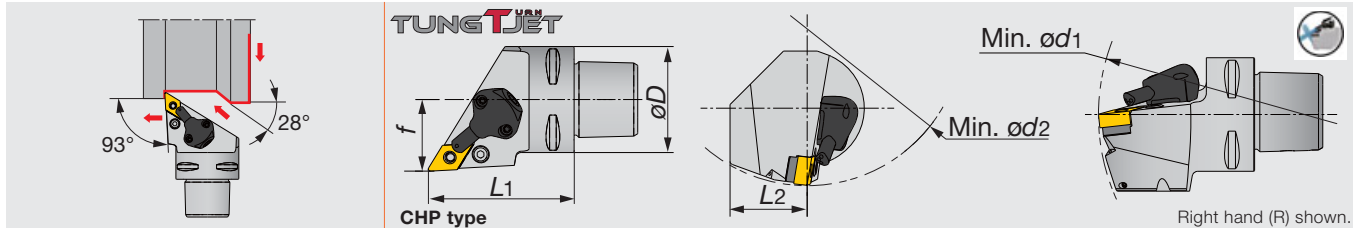

Designation	øD	L1	L2	f	ød1	ød2	rε**	Insert
C4PDJNR/L27055-1104-CHP	40	55	27	27	145	110	0.8	DN**1104...
C6PDJNR/L45065-1104-CHP	63	65	35	45	195	95	0.8	DN**1104...

Applicable for 14 MPa pressure coolant

SPARE PARTS						SPARE PARTS				
Designation	Shim	Clamping screw	Spring pin	Lever	Wrench 1	Designation	Coolant unit	Mounting screw	Wrench 2	O-ring
C*PDJNR/L**-1104-CHP	ELSD32	LCS3	LSP3	LCL33	P-2.5	C*PDJNR/L**-1104-CHP	CU-D-CHP	SRM3	T-8F	OR6.4X0.9N

C-PDMNL-CHP

Lever lock type toolholder with 93° approach angle. For negative 55° rhombic insert.

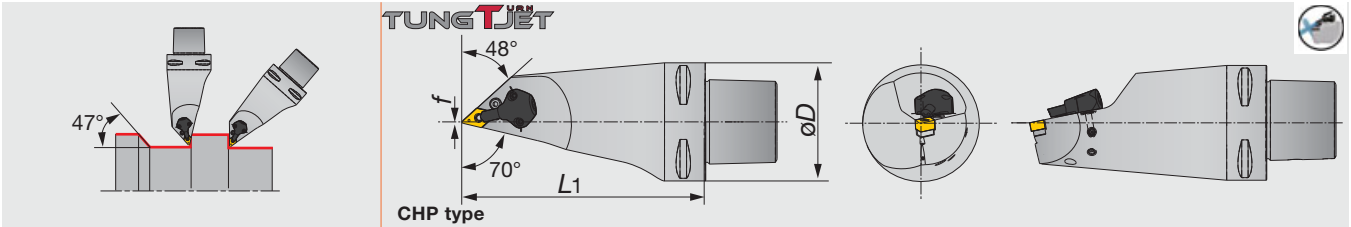

Designation	ϕD	L_1	L_2	f	ϕd_1	ϕd_2	r_{ϵ}^{**}	Insert
C6PDMNL00130-1104-CHP	63	130	-	0	-	-	0.8	DN**1104...

Applicable for 14 MPa pressure coolant.

SPARE PARTS						SPARE PARTS				
Designation	Shim	Clamping screw	Spring pin	Lever	Wrench 1	Designation	Coolant unit	Mounting screw	Wrench 2	O-ring
C6PDMNL00130-1104-CHP	ELSD32	LCS3	LSP3	LCL33L	P-2.5	C6PDMNL00130-1104-CHP	CU-D-CHP	SRM3	T-8F	OR6.4X0.9N

New

C-PVJNR/L-CHP

Lever lock type toolholder with 93° approach angle. For negative 35° rhombic inserts.

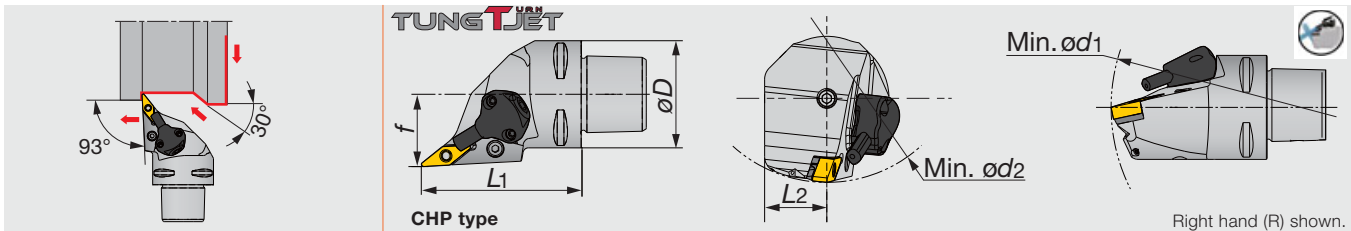

Designation	ϕD	L_1	L_2	f	ϕd_1	ϕd_2	r_{ϵ}^{**}	Insert
C4PVJNR/L27060-1204-CHP	40	60	20	27	140	90	0.8	VN**1204...
C6PVJNR/L45065-1204-CHP	63	65	31.5	45	190	81	0.8	VN**1204...

Applicable for 14 MPa pressure coolant.

SPARE PARTS						SPARE PARTS					
Designation	Shim	Clamping screw	Spring pin	Lever	Wrench 1	Designation	Coolant unit	Mounting screw	Wrench 2	O-ring	
C*PVJNR/L**-1204-CHP	LSV212	LCS3V	LSP3	LCL3V	P-2.5	P-3	C*PVJNR/L**-1204-CHP	CU-V-CHP	SRM3	T-8F	OR6.4X0.9N

STANDARD CUTTING CONDITIONS

P Steel

Application	Chipbreaker	Grades	Cutting speed V_c (m/min)			Depth of cut a_p (mm)	Feed f (mm/rev)
			Low carbon steels Alloy steels	Medium carbon steels Alloy steels	High carbon steels Alloy steels		
Finishing	TSF	NS9530	150 - 250	80 - 220	80 - 180	0.2 - 1.5	0.08 - 0.4
		GT9530	150 - 300	80 - 250	80 - 200		
		T9115	150 - 300	150 - 300	120 - 250		
		T9125	120 - 250	80 - 200	80 - 150		
	ZF	T9115	150 - 300	150 - 300	120 - 250	0.2 - 1.5	0.07 - 0.2
T9125	120 - 250	80 - 200	80 - 150				
Finishing (Wiper)	FW	T9105	180 - 350	180 - 350	180 - 300	0.5 - 1.5	0.2 - 0.4
		T9115	150 - 300	150 - 300	120 - 250		
		T9125	120 - 250	80 - 200	80 - 150		
		NS9530	150 - 250	80 - 220	80 - 180		
		GT9530	150 - 300	80 - 250	80 - 200		
Finishing to medium cutting	ZM	T9115	150 - 300	150 - 300	120 - 250	0.7 - 2.0	0.15 - 0.4
		T9125	120 - 250	80 - 200	80 - 150		
Finishing to medium cutting (Wiper)	SW	T9105	180 - 350	180 - 350	180 - 300	0.5 - 2.0	0.3 - 0.6
		T9115	150 - 300	150 - 300	120 - 250		
		T9125	120 - 250	80 - 200	80 - 150		
Finishing to medium cutting	NM	T9125	120 - 250	80 - 200	80 - 150	0.5 - 2.0	0.15 - 0.4
Medium cutting	TM	T9115	150 - 300	150 - 300	120 - 250	1.0 - 3.0	0.2 - 0.5
		T9125	120 - 250	80 - 200	80 - 150		

M Stainless

Application	Chipbreaker	Grades	Cutting speed V_c (m/min)			Depth of cut a_p (mm)	Feed f (mm/rev)
			Austenitic	Ferritic / Martensitic	Precipitation hardened		
Finishing	SS	AH630	90 - 190	110 - 210	60 - 90	0.5 - 3.0	0.08 - 0.2
		AH645	70 - 150	90 - 170	-		
Medium cutting	SM	T6120	140 - 240	160 - 280	80 - 150	1.0 - 3.0	0.2 - 0.5
		T6130	100 - 200	120 - 240	70 - 110		
		AH630	90 - 190	110 - 210	60 - 90		

K Cast Iron

Application	Chipbreaker	Grades	Cutting speed V_c (m/min)		Depth of cut a_p (mm)	Feed f (mm/rev)
			Grey cast irons	Ductile cast irons		
Finishing to medium cutting (Wiper)	SW	T5115	140 - 400	140 - 370	0.5 - 2.0	0.3 - 0.6
Medium cutting	TM	T515	150 - 700	140 - 370	1.0 - 3.0	0.2 - 0.5

S Superalloys and titanium

Application	Chipbreaker	Grades	Cutting speed V_c (m/min)		Depth of cut a_p (mm)	Feed f (mm/rev)
			Titanium alloys	Ni-base alloys		
Medium cutting	TM	AH8015	20 - 150	20 - 100	1.0 - 3.0	0.2 - 0.5

PRACTICAL EXAMPLES

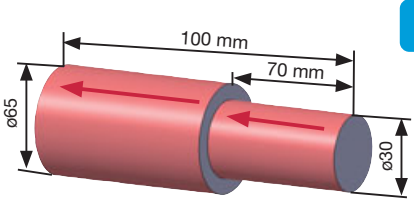
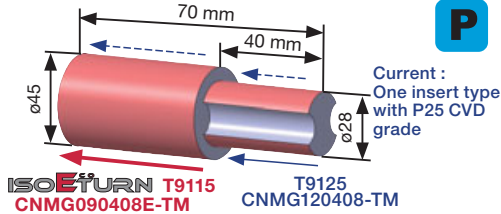
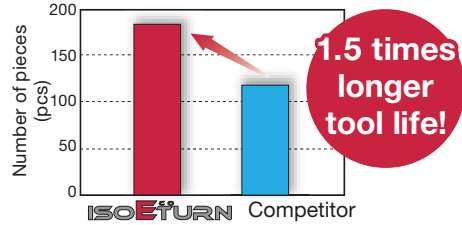
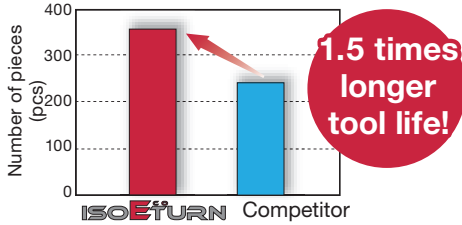
Workpiece type	Machine part	Machine part (Automated manufacturing line)	
Toolholder	ACLNL2525M0904-A	ACLNL2525M0904-A	
Insert	CNMG090408E-TM	CNMG090408E-TM	
Grade	T9115	T9115	
Workpiece material	S50C / C50	Low alloy steel	
			
Cutting conditions	Cutting speed: V_c (m/min)	180	230
	Feed : f (mm/rev)	0.2	0.25
	Depth of cut : a_p (mm)	3.0	2.0
	Machining	External turning (Continuous cutting)	External turning (Continuous cutting)
Coolant	Wet	Wet	
Results	 <p>Current insert: CNMG1204 type. ISO-EcoTurn demonstrates excellent chip control with 3 mm depth of cut. T9115 grade achieves 1.5 times longer tool life.</p>	 <p>Current P25 grade is suitable for interrupted parts, but not good for continuous cutting. By using ISO-EcoTurn, tool life of each insert drastically increases.</p>	



MEMO

A large grid of graph paper for taking notes, consisting of 20 columns and 30 rows of small squares.

Check our site and our App to get more info!

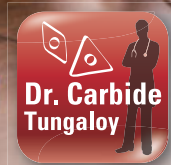
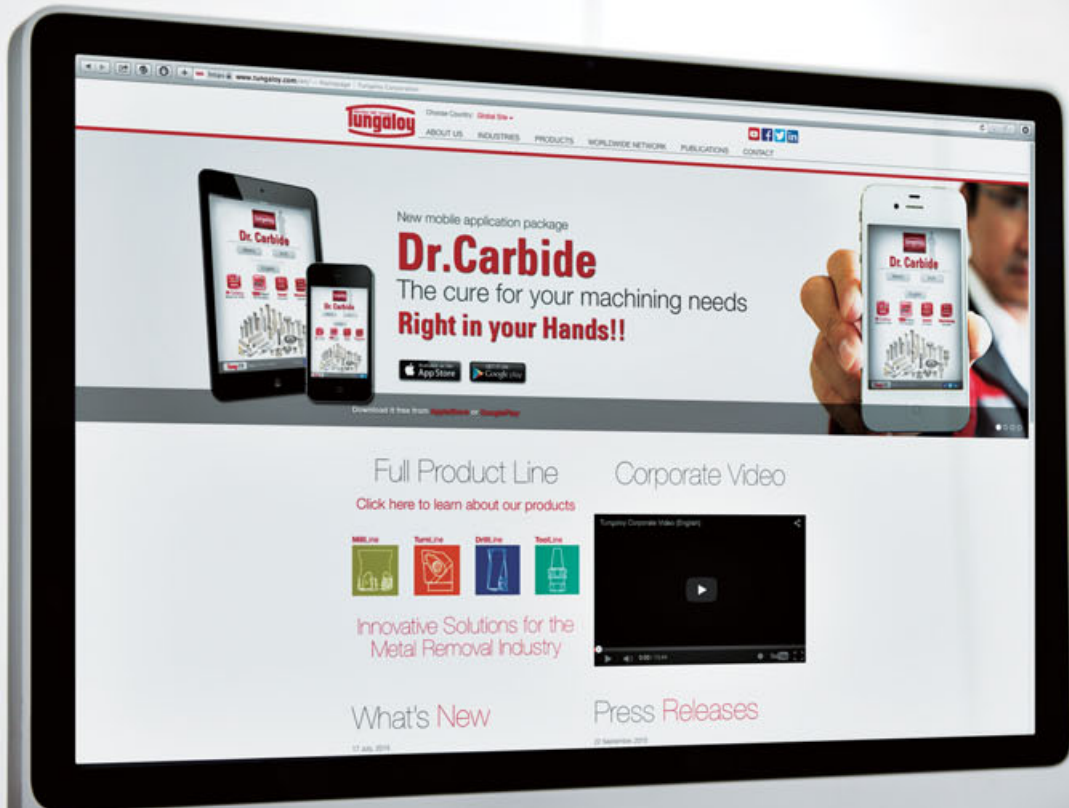

Tungaloy Corporation (Head office)

11-1 Yoshima-Kogyodanchi
Iwaki-city, Fukushima, 970-1144 Japan
Phone: +81-246-36-8501
Fax: +81-246-36-8542
www.tungaloy.co.jp

Tungaloy America, Inc.

3726 N Ventura Drive
Arlington Heights, IL 60004, U.S.A.
Phone: +1-888-554-8394
Fax: +1-888-554-8392
www.tungaloyamerica.com

Tungaloy Canada

432 Elgin St. Unit 3
Brantford, Ontario N3S 7P7, Canada
Phone: +1-519-758-5779
Fax: +1-519-758-5791
www.tungaloy.co.jp/ca

Tungaloy de Mexico S.A.

C Los Arellano 113,
Parque Industrial Siglo XXI
Aguascalientes, AGS, Mexico 20290
Phone: +52-449-929-5410
Fax: +52-449-929-5411
www.tungaloy.co.jp/mx

Tungaloy do Brasil Ltda.

Avd. Independencia N4158 Residencial Flora
13280-000 Vinhedo, São Paulo, Brasil
Phone: +55-19-38262757
Fax: +55-19-38262757
www.tungaloy.com/br

Tungaloy Germany GmbH

An der Alten Ziegelei 1
D-40789 Monheim, Germany
Phone: +49-2173-90420-0
Fax: +49-2173-90420-19
www.tungaloy.de

Tungaloy France S.A.S.

ZA Courtaboeuf - Le Rio
1 rue de la Terre de feu
F-91952 Courtaboeuf Cedex, France
Phone: +33-1-6486-4300
Fax: +33-1-6907-7817
www.tungaloy.fr

Tungaloy Italia S.r.l.

Via E. Andolfato 10
I-20126 Milano, Italy
Phone: +39-02-252012-1
Fax: +39-02-252012-65
www.tungaloy.it

Tungaloy Czech s.r.o.

Turanka 115
CZ-627 00 Brno, Czech Republic
Phone: +420-532 123 391
Fax: +420-532 123 392
www.tungaloy.cz

Tungaloy Ibérica S.L.

C/Miquel Servet, 43B, Nau 7
Pol. Ind. Bufalvent
ES-08243 Manresa (BCN), Spain
Phone: +34 93 113 1360
Fax: +34 93 876 2798
www.tungaloy.es

Tungaloy Scandinavia AB

Bultgatan 38
442 40 Kungälv, Sweden
Phone: +46-462119200
www.tungaloy.se

Tungaloy Rus, LLC

36-D Harkovsky Lane
308009 Belgorod, Russia
Phone: +7 4722 24 00 07
Fax: +7 4722 24 00 08
www.tungaloy.co.jp/ru

Tungaloy East LLC

Stachek str., h.4, office 2, Ekaterinburg,
620017, Russia
Phone: +7-343-389-13-22
Fax: +7-343-278-94-35
www.tungaloy.co.jp/rue

Tungaloy Polska Sp. z o.o.

ul. Genewska 24
03-963 Warszawa, Poland
Phone: +48-22-617-0890
Fax: +48-22-617-0890
www.tungaloy.co.jp/pl

Tungaloy U.K. Ltd

The Technology Centre,
Wolverhampton Science Park
Glaisher Drive, Wolverhampton
West Midlands WV10 9RU, UK
Phone: +44 121 4000 231
Fax: +44 121 270 9694
www.tungaloy.co.jp/uk
salesinfo@tungaloyuk.co.uk

Tungaloy Hungary Kft

Erzsébet királyné útja 125
H-1142 Budapest, Hungary
Phone: +36 1 781-6846
Fax: +36 1 781-6866
www.tungaloy.co.jp/hu
info@tungaloytools.hu

Tungaloy Turkey

Dudullu.OSB 4. Cad No:4
34776 Umraniye Istanbul, TURKEY
Phone: +90 216 540 04 67
Fax: +90 216 540 04 87
www.tungaloy.com.tr
info@tungaloy.com.tr

Tungaloy Benelux b.v.

Tjalk 70
NL-2411 NZ Bodegraven, Netherlands
Phone: +31 172 630 420
Fax: +31 172 630 429
www.tungaloy-benelux.com

Tungaloy Croatia

Josipa Kozarca 4
10432 Bregana, Croatia
Phone: +385 1 3326 604
Fax: +385 1 3327 683
www.tungaloy.hr

Tungaloy Cutting Tool (Shanghai) Co.,Ltd.

Rm No 401 No.88 Zhabei
Jiangchang No.3 Rd
Shanghai 200436, China
Phone: +86-21-3632-1880
Fax: +86-21-3621-1918
www.tungaloy.co.jp/tcts

Tungaloy Cutting Tool (Thailand) Co.,Ltd.

Interlink tower 4th Fl.
1858/5-7 Bangna-Trad Road
km.5 Bangna, Bangna, Bangkok 10260
Thailand
Phone: +66-2-751-5711
Fax: +66-2-751-5715
www.tungaloy.co.th

Tungaloy Singapore (Pte.), Ltd.

62 Ubi Road 1, #06-11 Oxley BizHub 2
Singapore 408734
Phone: +65-6391-1833
Fax: +65-6299-4557
www.tungaloy.co.jp/tspl

Tungaloy Vietnam

Unit 18, 4th Fl. Saigon Centre Building
65 Le Loi Blvd.
Dist 1, Ho Chi Minh City, Vietnam
Phone: +84-8-3827-0201
Fax: +84-8-3827-0203
www.tungaloy.co.jp/tspl

Tungaloy India Pvt. Ltd.

Indiabulls Finance Centre,
Unit # 902-A, 9th Floor,
Tower 1, Senapati Bapat Marg,
Elphinstone Road (West),
Mumbai -400013, India
Phone: +91-22-6124-8804
Fax: +91-22-6124-8899
www.tungaloy.co.jp/in

Tungaloy Korea Co., Ltd

#1312, Byucksan Digital Valley 5-cha
Beotkkot-ro 244, Geumcheon-gu
153-788 Seoul, Korea
Phone: +82-2-2621-6161
Fax: +82-2-6393-8952
www.tungaloy.co.jp/kr

Tungaloy Malaysia Sdn Bhd

50 K-2, Kelana Mall, Jalan SS6/14
Kelana Jaya, 47301
Petaling Jaya, Selangor Darul Ehsan
Malaysia
Phone: +603-7805-3222
Fax: +603-7804-8563
www.tungaloy.com.my

Tungaloy Australia Pty Ltd

PO Box 2232, Rowville,
Victoria 3178, Australia
Phone: +61-3-9755-8147
Fax: +61-3-9755-6070
www.tungaloy.com.au

PT. Tungaloy Indonesia

Kompleks Grand Wisata Block AA-10 No.3-5
Cibitung
Bekasi 17510, Indonesia
Phone: +62-21-8261-5808
Fax: +62-21-8261-5809
www.tungaloy.co.jp/id



www.tungaloy.com

follow us at:

facebook.com/tungaloyjapan

twitter.com/tungaloyjapan

To see this product in action visit:

Tung-TV

www.youtube.com/tungaloycorporation

Distributed by:



DOWNLOAD
Dr. Carbide App



Available on the
App Store



GET IT ON
Google play



AS9100 Certified
78006
2015.11.04
ISO14001 Certified
EC97J1123
1997.11.26