

DrillLine

TUNGSIK-DRILL

www.tungaloy.com

Tungaloy Report No. 409-G

TUNGSIK-DRILL

The most economical solution
for drilling!



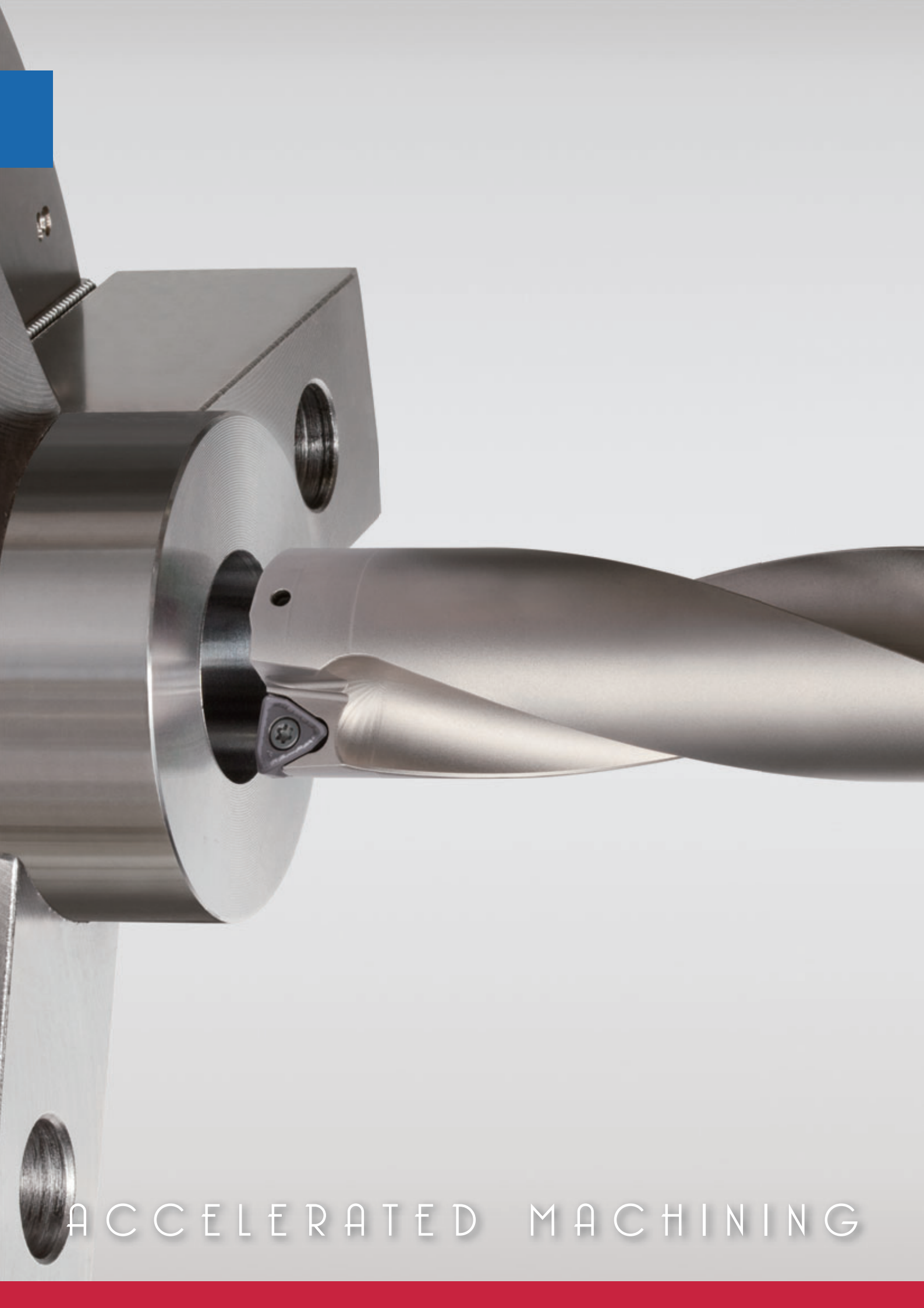

ACCELERATED MACHINING

DrillLine

TUNG SIX-DRILL



First double sided 6 cornered insert for drilling with superior performance.

Indexable drill

6 cornered insert with high performance and high economical solution

Double-sided insert with 6-cutting edges

TungSixDrill is the first indexable drill in the world to adapt double-sided inserts with 6-cutting edges, reducing the insert consumption for the customers.

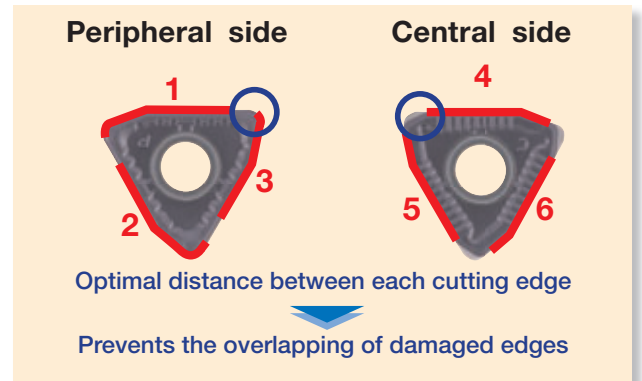

One insert type for both the central and peripheral pockets



Low cutting force even with double sided insert

The cutting forces are almost equal to competitors positive single sided inserts, especially at higher feed rates, thus complementing higher productivity.

Spindle load

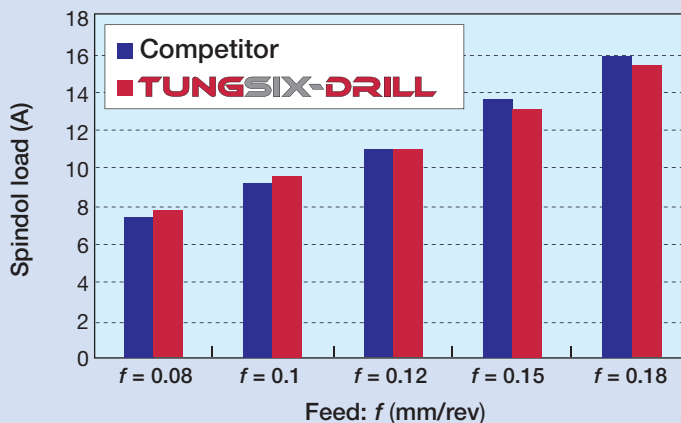

Drill : TDS200F25-3
 Insert : WWMU05X205R-DJ
 Grade : AH9030
 Workpiece : S55C / C55
 Cutting speed : $V_c = 150$ m/min
 Feed : $f = 0.08 - 0.18$ mm/rev
 Hole diameter : $\varnothing 20$ mm

New revolutionary grade

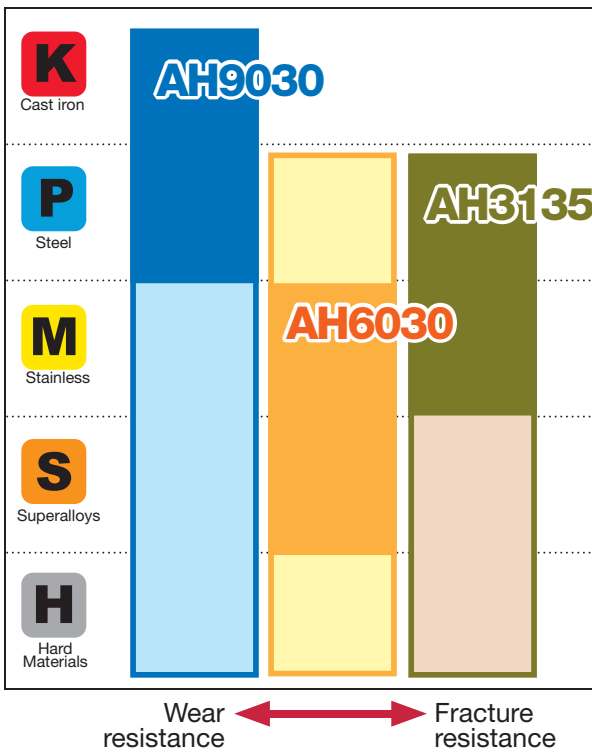

AH9030

Special Surface Technology

PREMIUMTEC

- Smooth insert surface prevents chip adhesion and provides smooth chip flow.
- New generation PVD coating with advanced wear and oxidation resistance provides stable long tool life.
- Unique substrate with high heat-resistance prevents crater wear.

AH6030

Special Surface Technology

PREMIUMTEC

- Smooth insert surface prevents chip adhesion and improves chip control.
- New PVD coating with high adhesion strength prevents fracture caused by chip welding.
- Exclusive carbide substrate with high fracture resistance.

AH3135

Special Surface Technology

PREMIUMTEC

- Multi-layered coating prevents crack expansion which causes chipping and fracture.
- Exclusive carbide substrate with remarkable impact resistance and toughness.

Enhanced corner of central insert

The central corner is strengthened by an obtuse angle relief thus increasing the corner strength and reliability.

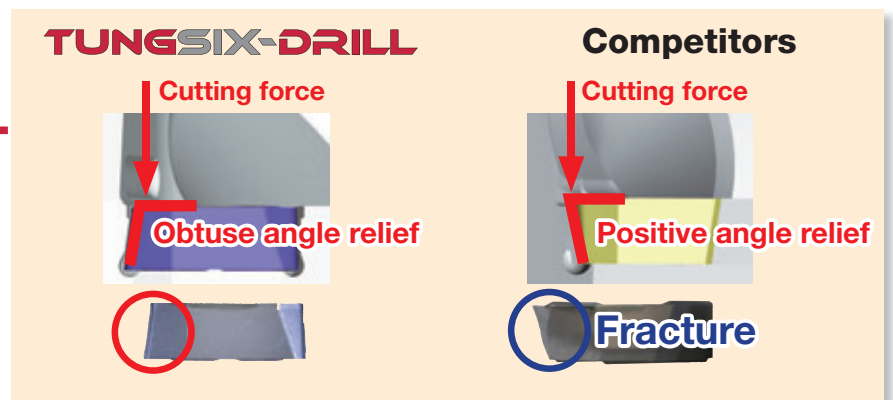
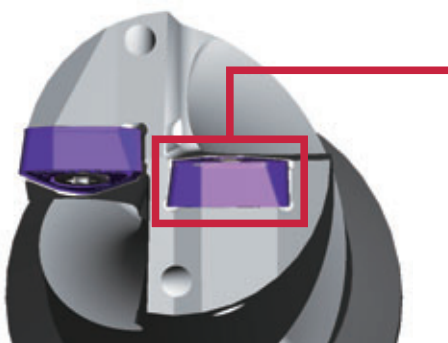

Twisted coolant holes

Twisted coolant holes improve coolant flow, improving chip evacuation, cooling and lubrication of the cutting edges.



Chipbreakers

DJ type For General purpose
Suitable for cutting of a wide range of work material

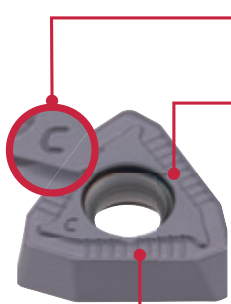
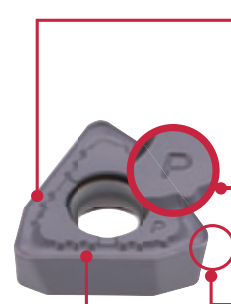
Central insert	Peripheral insert
<p>Identification for central edge side</p>  <p>Chipbreaker for central edge The chipbreaker has thick width and gentle curves. This prevents chips from packing.</p> <p>Low cutting forces and long tool life Optimised rake design reduces chip contact with the insert, reducing heat and improving tool life.</p>	<p>Chipbreaker for peripheral edge The high rake angle and high breaker wall reduce cutting forces and improve chipbreaking.</p> <p>Identification for peripheral edge side</p>  <p>Wiper design Can improve surface finish</p>

* WWMU05... and WWMU06...does not have 'P' mark on the peripheral side.

DS type For drilling stainless and gummy steels
Demonstrates exceptional chip control

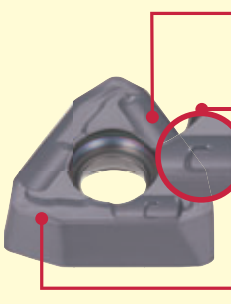
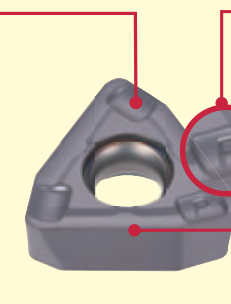



Central insert	Peripheral insert
<p>Dimple Creates smooth chip curling.</p> <p>Identification for central edge side</p>  <p>Reinforced land Prevents fracture and chipping.</p>	<p>Identification for peripheral edge side</p>  <p>Optimum chipbreaker width and contact area Provides excellent chip control.</p>

* WWMU05... and WWMU06...does not have 'P' mark on the peripheral side.

System to avoid wrong insert clamping

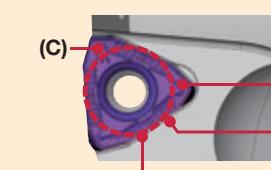
TungSix-Drill insert and pocket design ensures correct insert positioning and clamping of central and peripheral inserts on its respective pockets.

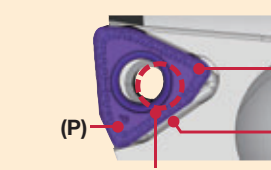
Note: The drill is designed to avoid wrong insert clamping, however please check the central (c) and peripheral (p) marks on the insert before setting the insert.

Correct clamping	Incorrect clamping
<p>OK Central insert ▶ Central insert seat</p>  <p>Insert hole fits screw hole</p>  <p>Correctly clamped !</p>	<p>X Peripheral insert ▶ Central insert seat</p>  <p>Insert hole doesn't fit screw hole</p>  <p>Screw can't enter screw hole</p>

Chip control

P

Steel

S45C / C45

DJ



Feed: f (mm/rev)	Cutting speed: V_c (m/min)		
	100	150	200
0.2			
0.15			
0.1			

The above parameter zone shows ideal chip control.

Drill : TDS280F32-3
 Insert : WWMU08X408R-DJ
 Grade : AH9030
 Machine : NC lathe
 Hool diameter: $\phi 28$ mm
 Hole depth : $H = 70$ mm
 Coolant : Wet

M

Stainless

SUS316L / X5CrNiMo17-12-3

DS



Feed: f (mm/rev)	Cutting speed: V_c (m/min)	
	150	200
0.1		
0.08		

The above parameter's zone shows ideal chip control. DS chip-breaker shows excellent chip control for stainless steel and difficult to split chips.

Drill : TDS280F32-3
 Insert : WWMU08X408R-DS
 Grade : AH6030
 Machine : Vertical M/C
 Hool diameter: $\phi 28$ mm
 Hole depth : $H = 70$ mm
 Coolant : Wet



Tool life

■ Excellent wear resistance of AH9030

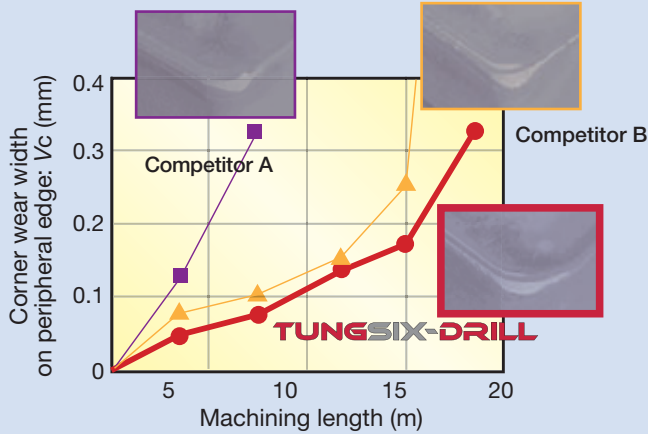

P
 Drill : TDS280F32-3
 Insert : WWMU08X408R-DJ
 Grade : AH9030
 Workpiece : S55C / C55
 Cutting speed : $V_c = 140$ m/min
 Feed : $f = 0.1$ mm/rev
 Hole diameter : $\phi 28$ mm
 Hole depth : $H = 84$ mm
 Machine : Horizontal M/C, BT40
 Coolant : Wet (Internal supply)

AH9030 offers superior wear resistance against competitors.

■ Toughness of central insert

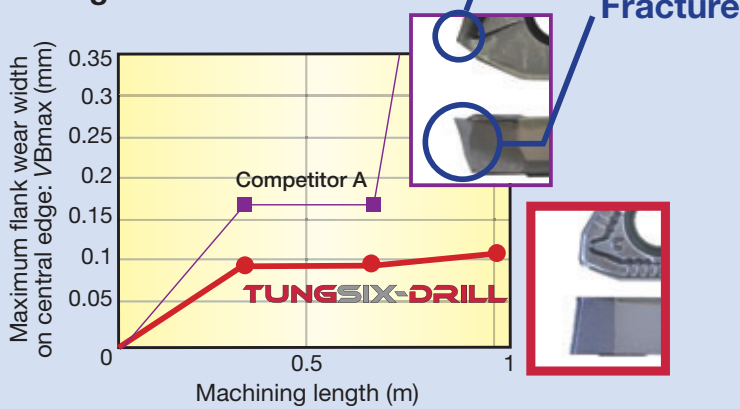

P
 Drill : TDS280F32-3
 Insert : WWMU08X408R-DJ
 Grade : AH9030
 Workpiece : Pre-hardened steel (40HRC)
 Cutting speed : $V_c = 100$ m/min
 Feed : $f = 0.08$ mm/rev
 Hole diameter : $\phi 28$ mm
 Hole depth : $H = 28$ mm
 Machine : Vertical M/C, BT50
 Coolant : Wet (Internal supply)

Enhanced corner of central cutting edge prevents fracture even in pre-hardened steel machining.

Standard cutting conditions

ISO	Workpiece materials	Selection criteria	Chip-breaker	Grade	Cutting speed V_c (m/min)
P	Low carbon steels (C < 0.3) SS400, SM490, S25C etc. (St42-1, St52-3, C25 etc.)	First choice	DS	AH6030	160 - 250
		Priority on wear resistance	DJ	AH9030	160 - 320
	Carbon steels (C > 0.3) S45C, S55C etc. (C45, C55 etc.)	First choice	DJ	AH9030	80 - 250
		Priority on impact resistance	DJ	AH3135	80 - 250
		Low alloy steels SCM415 etc.	First choice	DS	AH6030
Alloy steels SCM440, SCr420 etc. (42CrMo4, 20Cr4 etc.)	Priority on wear resistance	DJ	AH9030	160 - 250	
	First choice	DJ	AH9030	80 - 200	
M	Stainless steels (Austenitic) SUS304, SUS316 etc. (X5CrNi18-9, X5CrNiMo17-12-2 etc.)	First choice	DS	AH6030	100 - 200
		Priority on impact resistance	DJ	AH3135	100 - 200
	Stainless steels (Martensitic and ferritic) SUS430, SUS416 etc. (X6Cr17, X20Cr13 etc.)	First choice	DS	AH6030	100 - 200
		Priority on impact resistance	DJ	AH3135	100 - 200
		Stainless steels (Precipitation hardening) SUS630 etc. (X5CrNiCuNb16-4 etc.)	First choice	DS	AH6030
Priority on impact resistance	DJ	AH3135	80 - 120		
K	Grey cast irons FC250 etc. (GG25 etc.)	First choice	DJ	AH9030	80 - 250
		Priority on impact resistance	DJ	AH3135	80 - 200
	Ductile cast irons FCD700 etc. (GGG70 etc.)	First choice	DJ	AH9030	80 - 200
Priority on impact resistance	DJ	AH3135	80 - 150		
N	Aluminium alloy	First choice	DS	AH6030	200 - 400
		-	DJ	AH9030	200 - 400
S	High temperature alloy Inconel718 etc.	First choice	DS	AH6030	20 - 60
		Priority on impact resistance	DJ	AH3135	20 - 60
	Titanium Alloy Ti-6Al-4V etc.	First choice	DS	AH6030	40 - 120
Priority on impact resistance	DJ	AH3135	40 - 120		
H	Hardened steel Over 40HRC	First choice	DJ	AH9030	50 - 100
		Priority on impact resistance	DJ	AH3135	40 - 80

P

■ Comparison of tool life for steel (AH9030)

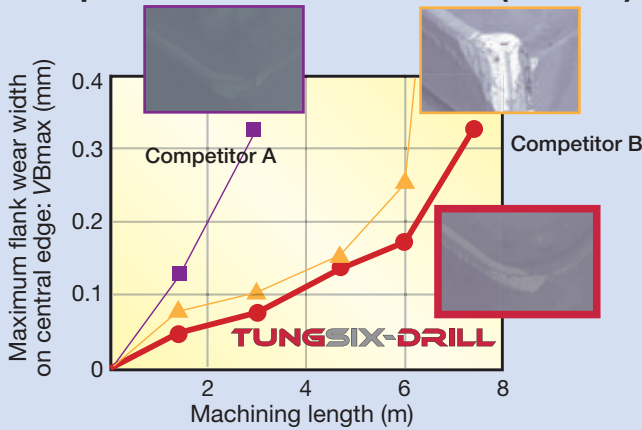

Drill : TDS280F32-3
 Insert : WWMU08X408R-DJ
 Grade : AH9030
 Workpiece : S55C / C55
 Cutting speed: $V_c = 250$ m/min
 Feed : $f = 0.1$ mm/rev
 Hole diameter : $\phi 28$ mm
 Hole depth : $H = 84$ mm
 Machine : Horizontal M/C, BT40
 Coolant : Wet (Internal supply)

The wear and oxidation resistance of AH9030 is enhanced in high speed machining.

M

■ Comparison of tool life for stainless steel (AH6030)

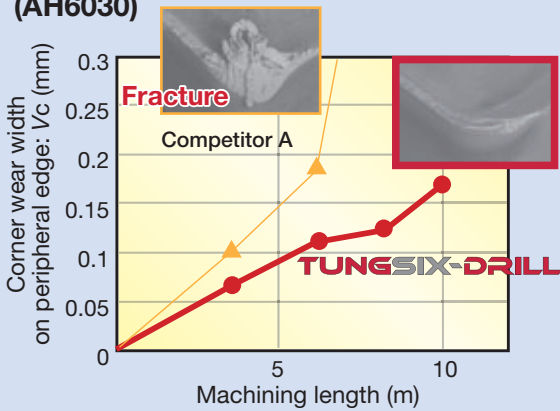

Comparison of damage on edge (After 6.7m machining)

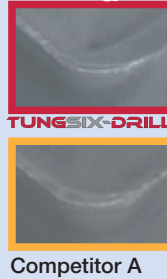

Drill : TDS280F32-3
 Insert : WWMU08X408R-DS
 Grade : AH6030
 Workpiece : SUS304 / X5CrNi18-9
 Cutting speed: $V_c = 200$ m/min
 Feed : $f = 0.1$ mm/rev
 Hole diameter : $\phi 28$ mm
 Hole depth : $H = 84$ mm
 Machine : Vertical M/C, BT50
 Coolant : Wet (Internal supply)

Even when machining stainless steel, cutting edge damage on AH6030 is minimal. This is credit to its high adhesion strength.

Feed: f (mm/rev)



L/D = 2, 3			L/D = 4		
ϕD_c (mm)			ϕD_c (mm)		
$\phi 20 - \phi 27.5$	$\phi 28 - \phi 38$	$\phi 39 - \phi 54$	$\phi 20 - \phi 27$	$\phi 28 - \phi 38$	$\phi 39 - \phi 54$
0.04 - 0.10	0.04 - 0.10	0.04 - 0.10	0.04 - 0.10	0.04 - 0.10	0.04 - 0.10
0.04 - 0.10	0.04 - 0.10	0.04 - 0.10	0.04 - 0.10	0.04 - 0.10	0.04 - 0.10
0.06 - 0.15	0.06 - 0.16	0.08 - 0.18	0.06 - 0.15	0.06 - 0.15	0.08 - 0.17
0.04 - 0.12	0.04 - 0.13	0.04 - 0.15	0.04 - 0.12	0.04 - 0.13	0.04 - 0.15
0.04 - 0.12	0.04 - 0.12	0.04 - 0.12	0.04 - 0.12	0.04 - 0.12	0.04 - 0.12
0.06 - 0.12	0.06 - 0.14	0.06 - 0.14	0.06 - 0.12	0.06 - 0.14	0.06 - 0.14
0.06 - 0.15	0.06 - 0.16	0.08 - 0.18	0.06 - 0.15	0.06 - 0.15	0.08 - 0.17
0.04 - 0.12	0.04 - 0.13	0.04 - 0.15	0.04 - 0.12	0.04 - 0.13	0.04 - 0.15
0.04 - 0.10	0.04 - 0.12	0.04 - 0.12	0.04 - 0.10	0.04 - 0.12	0.04 - 0.12
0.04 - 0.10	0.04 - 0.12	0.04 - 0.12	0.04 - 0.10	0.04 - 0.12	0.04 - 0.12
0.04 - 0.10	0.04 - 0.12	0.04 - 0.12	0.04 - 0.10	0.04 - 0.12	0.04 - 0.12
0.04 - 0.10	0.04 - 0.12	0.04 - 0.12	0.04 - 0.10	0.04 - 0.12	0.04 - 0.12
0.04 - 0.10	0.04 - 0.10	0.04 - 0.10	0.04 - 0.10	0.04 - 0.10	0.04 - 0.10
0.04 - 0.10	0.04 - 0.10	0.04 - 0.10	0.04 - 0.10	0.04 - 0.10	0.04 - 0.10
0.06 - 0.15	0.06 - 0.18	0.08 - 0.20	0.06 - 0.15	0.06 - 0.16	0.08 - 0.18
0.06 - 0.13	0.06 - 0.16	0.08 - 0.18	0.06 - 0.13	0.06 - 0.16	0.08 - 0.18
0.06 - 0.15	0.06 - 0.18	0.08 - 0.20	0.06 - 0.15	0.06 - 0.16	0.08 - 0.18
0.06 - 0.13	0.06 - 0.16	0.08 - 0.18	0.06 - 0.13	0.06 - 0.16	0.08 - 0.18
0.10 - 0.18	0.10 - 0.20	0.10 - 0.25	0.10 - 0.18	0.10 - 0.20	0.10 - 0.20
0.10 - 0.18	0.10 - 0.20	0.10 - 0.25	0.10 - 0.18	0.10 - 0.20	0.10 - 0.20
0.04 - 0.08	0.04 - 0.08	0.04 - 0.10	0.04 - 0.08	0.04 - 0.08	0.04 - 0.10
0.04 - 0.08	0.04 - 0.08	0.04 - 0.10	0.04 - 0.08	0.04 - 0.08	0.04 - 0.10
0.06 - 0.10	0.06 - 0.12	0.06 - 0.14	0.06 - 0.10	0.06 - 0.12	0.06 - 0.14
0.06 - 0.10	0.06 - 0.12	0.06 - 0.14	0.06 - 0.10	0.06 - 0.12	0.06 - 0.14
0.04 - 0.08	0.04 - 0.08	0.04 - 0.10	0.04 - 0.08	0.04 - 0.08	0.04 - 0.08
0.04 - 0.08	0.04 - 0.08	0.04 - 0.10	0.04 - 0.08	0.04 - 0.08	0.04 - 0.08

Drills

L/D = 2

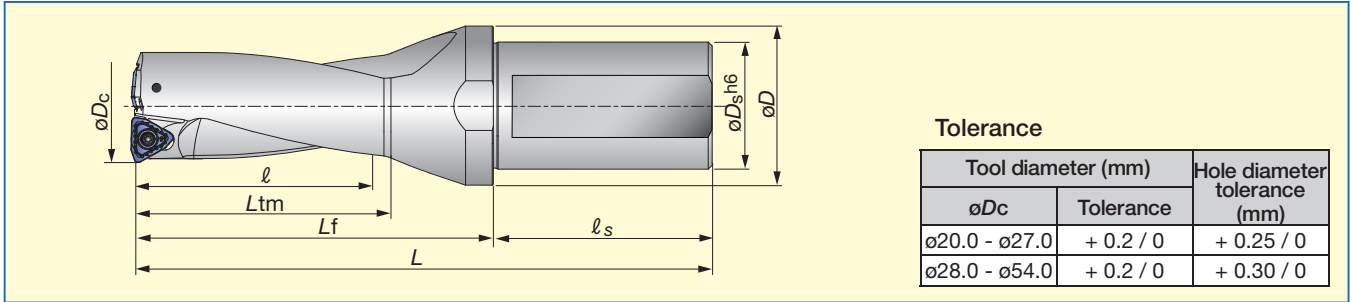
Machined hole diameter may change depending upon the rigidity of the machine tool or cutting conditions.





Designation	Stock	Dimensions (mm)								Max offset (Radius)	Weight (kg)	Applicable inserts	Clamping screw 	Torx driver 
		øDc	øDs	øD	ℓ	Ltm	Lf	ℓs	L					
TDS200F25-2	●	20.0	25	32	40	44	61.0	54	115.0	1.0	0.3	WWMU05X205R-D*	CSPB-2.2	IP-7D
TDS205F25-2	●	20.5	25	32	41	45	62.5	54	116.5	0.9	0.3	WWMU05X205R-D*	CSPB-2.2	IP-7D
TDS210F25-2	●	21.0	25	32	42	46	64.0	54	118.0	0.8	0.3	WWMU05X205R-D*	CSPB-2.2	IP-7D
TDS215F25-2	●	21.5	25	32	43	47	65.0	54	119.0	0.6	0.3	WWMU05X205R-D*	CSPB-2.2	IP-7D
TDS220F25-2	●	22.0	25	32	44	48	66.0	54	120.0	0.5	0.3	WWMU05X205R-D*	CSPB-2.2	IP-7D
TDS225F25-2	●	22.5	25	37	45	49	67.5	54	121.5	0.4	0.3	WWMU05X205R-D*	CSPB-2.2	IP-7D
TDS230F25-2	●	23.0	25	37	46	50	69.0	54	123.0	0.3	0.4	WWMU05X205R-D*	CSPB-2.2	IP-7D
TDS235F25-2	●	23.5	25	37	47	51	70.0	54	124.0	0.2	0.4	WWMU05X205R-D*	CSPB-2.2	IP-7D
TDS240F25-2	●	24.0	25	37	48	52	71.0	54	125.0	1.2	0.4	WWMU060306R-D*	CSPB-2.5	IP-8D
TDS245F25-2	●	24.5	25	37	49	53	72.5	54	126.5	1.0	0.4	WWMU060306R-D*	CSPB-2.5	IP-8D
TDS250F25-2	●	25.0	25	37	50	54	74.0	54	128.0	0.8	0.4	WWMU060306R-D*	CSPB-2.5	IP-8D
TDS255F25-2	●	25.5	25	37	51	55	75.5	54	129.5	0.6	0.4	WWMU060306R-D*	CSPB-2.5	IP-8D
TDS260F25-2	●	26.0	25	37	52	56	77.0	54	131.0	0.5	0.4	WWMU060306R-D*	CSPB-2.5	IP-8D
TDS270F32-2	●	27.0	32	40	54	58	79.0	59	138.0	0.3	0.6	WWMU060306R-D*	CSPB-2.5	IP-8D
TDS280F32-2	●	28.0	32	40	56	60	82.0	59	141.0	1.3	0.6	WWMU08X408R-D*	CSTB-3	T-9D
TDS290F32-2	●	29.0	32	40	58	62	84.0	59	143.0	1.1	0.7	WWMU08X408R-D*	CSTB-3	T-9D
TDS300F32-2	●	30.0	32	40	60	64	87.0	59	146.0	0.8	0.7	WWMU08X408R-D*	CSTB-3	T-9D
TDS310F32-2	●	31.0	32	40	62	66	90.0	59	149.0	0.5	0.7	WWMU08X408R-D*	CSTB-3	T-9D
TDS320F32-2	●	32.0	32	40	64	68	92.0	59	151.0	0.2	0.8	WWMU08X408R-D*	CSTB-3	T-9D
TDS330F40-2	●	33.0	40	50	66	70	95.0	69	164.0	1.7	1.2	WWMU09X510R-D*	CSTB-4	T-15D
TDS340F40-2	●	34.0	40	50	68	72	98.0	69	167.0	1.4	1.2	WWMU09X510R-D*	CSTB-4	T-15D
TDS350F40-2	●	35.0	40	50	70	74	101.0	69	170.0	1.2	1.2	WWMU09X510R-D*	CSTB-4	T-15D
TDS360F40-2	●	36.0	40	50	72	76	104.0	69	173.0	0.9	1.3	WWMU09X510R-D*	CSTB-4	T-15D
TDS370F40-2	●	37.0	40	50	74	78	105.0	69	174.0	0.7	1.3	WWMU09X510R-D*	CSTB-4	T-15D
TDS380F40-2	●	38.0	40	50	76	80	108.0	69	177.0	0.4	1.3	WWMU09X510R-D*	CSTB-4	T-15D
TDS390F40-2	●	39.0	40	50	78	82	110.0	69	179.0	2.2	1.4	WWMU11X512R-D*	CSTB-5	T-20D
TDS400F40-2	●	40.0	40	50	80	84	113.0	69	182.0	1.9	1.4	WWMU11X512R-D*	CSTB-5	T-20D
TDS410F40-2	●	41.0	40	50	82	86	117.0	69	186.0	1.7	1.5	WWMU11X512R-D*	CSTB-5	T-20D
TDS420F40-2	●	42.0	40	55	84	88	119.0	69	188.0	1.5	1.6	WWMU11X512R-D*	CSTB-5	T-20D
TDS430F40-2	●	43.0	40	55	86	90	122.0	69	191.0	1.3	1.6	WWMU11X512R-D*	CSTB-5	T-20D
TDS440F40-2	●	44.0	40	55	88	92	124.0	69	193.0	1.0	1.7	WWMU11X512R-D*	CSTB-5	T-20D
TDS450F40-2	●	45.0	40	55	90	94	127.0	69	196.0	0.7	1.7	WWMU11X512R-D*	CSTB-5	T-20D
TDS460F40-2	●	46.0	40	55	92	96	130.0	69	199.0	0.4	1.8	WWMU11X512R-D*	CSTB-5	T-20D
TDS470F40-2	●	47.0	40	55	94	98	132.0	69	201.0	2.6	1.9	WWMU13X512R-D*	CSTB-5	T-20D
TDS480F40-2	●	48.0	40	55	96	100	135.0	69	204.0	2.4	1.9	WWMU13X512R-D*	CSTB-5	T-20D
TDS490F40-2	●	49.0	40	55	98	102	137.0	69	206.0	2.2	1.9	WWMU13X512R-D*	CSTB-5	T-20D
TDS500F40-2	●	50.0	40	55	100	104	140.0	69	209.0	2.0	2.0	WWMU13X512R-D*	CSTB-5	T-20D
TDS510F40-2	●	51.0	40	55	102	106	144.0	69	213.0	1.7	2.1	WWMU13X512R-D*	CSTB-5	T-20D
TDS520F40-2	●	52.0	40	55	104	108	146.0	69	215.0	1.5	2.2	WWMU13X512R-D*	CSTB-5	T-20D
TDS530F40-2	●	53.0	40	55	106	110	149.0	69	218.0	1.3	2.3	WWMU13X512R-D*	CSTB-5	T-20D
TDS540F40-2	●	54.0	40	55	108	112	151.0	69	220.0	1.0	2.4	WWMU13X512R-D*	CSTB-5	T-20D

● : Stocked items

L/D = 3

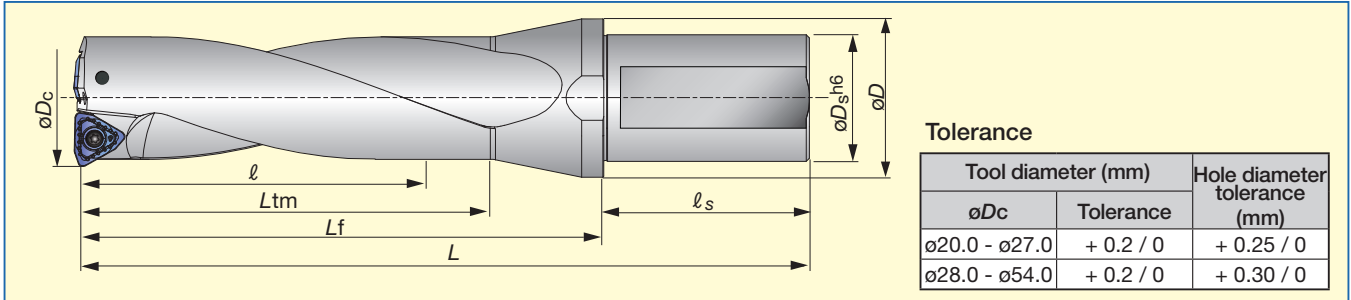
Machined hole diameter may change depending upon the rigidity of the machine tool or cutting conditions.



Designation	Stock	Dimensions (mm)								Max offset (Radius)	Weight (kg)	Applicable inserts	Clamping screw 	Torx driver 
		ϕD_c	ϕD_s	ϕD	ℓ	L_{tm}	L_f	ℓ_s	L					
TDS200F25-3	●	20.0	25	32	60.0	64.0	81.0	54	135.0	1.0	0.3	WWMU05X205R-D*	CSPB-2.2	IP-7D
TDS205F25-3	●	20.5	25	32	61.5	65.5	82.0	54	136.0	0.9	0.3	WWMU05X205R-D*	CSPB-2.2	IP-7D
* TDS209F25-3	●	20.9	25	32	62.7	66.7	84.0	54	138.0	0.8	0.3	WWMU05X205R-D*	CSPB-2.2	IP-7D
TDS210F25-3	●	21.0	25	32	63.0	67.0	84.0	54	138.0	0.8	0.4	WWMU05X205R-D*	CSPB-2.2	IP-7D
TDS215F25-3	●	21.5	25	32	64.5	68.5	86.0	54	140.0	0.6	0.4	WWMU05X205R-D*	CSPB-2.2	IP-7D
TDS220F25-3	●	22.0	25	32	66.0	70.0	87.0	54	141.0	0.5	0.4	WWMU05X205R-D*	CSPB-2.2	IP-7D
** TDSU0875F25-3	●	22.2	25	32	66.0	70.0	87.0	54	141.0	0.4	0.4	WWMU05X205R-D*	CSPB-2.2	IP-7D
TDS225F25-3	●	22.5	25	37	67.5	71.5	90.0	54	144.0	0.4	0.4	WWMU05X205R-D*	CSPB-2.2	IP-7D
TDS230F25-3	●	23.0	25	37	69.0	73.0	91.0	54	145.0	0.3	0.4	WWMU05X205R-D*	CSPB-2.2	IP-7D
TDS235F25-3	●	23.5	25	37	70.5	74.5	93.0	54	147.0	0.2	0.4	WWMU05X205R-D*	CSPB-2.2	IP-7D
* TDS239F25-3	●	23.9	25	37	71.7	75.7	95.0	54	149.0	1.2	0.4	WWMU060306R-D*	CSPB-2.5	IP-8D
TDS240F25-3	●	24.0	25	37	72.0	76.0	95.0	54	149.0	1.2	0.4	WWMU060306R-D*	CSPB-2.5	IP-8D
TDS245F25-3	●	24.5	25	37	73.5	77.5	97.0	54	151.0	1.0	0.5	WWMU060306R-D*	CSPB-2.5	IP-8D
TDS250F25-3	●	25.0	25	37	75.0	79.0	99.0	54	153.0	0.8	0.5	WWMU060306R-D*	CSPB-2.5	IP-8D
TDS255F25-3	●	25.5	25	37	76.5	80.5	100.0	54	154.0	0.6	0.5	WWMU060306R-D*	CSPB-2.5	IP-8D
* TDS260F25-3	●	26.0	25	37	78.0	82.0	102.0	54	156.0	0.5	0.5	WWMU060306R-D*	CSPB-2.5	IP-8D
TDS264F32-3	●	26.4	32	40	79.2	83.2	103.5	59	162.5	0.4	0.6	WWMU060306R-D*	CSPB-2.5	IP-8D
TDS265F32-3	●	26.5	32	40	79.5	83.5	103.5	59	162.5	0.4	0.6	WWMU060306R-D*	CSPB-2.5	IP-8D
TDS270F32-3	●	27.0	32	40	81.0	85.0	105.0	59	164.0	0.3	0.6	WWMU060306R-D*	CSPB-2.5	IP-8D
TDS275F32-3	●	27.5	32	40	82.0	86.0	108.0	59	167.0	0.0	0.6	WWMU08X408R-D*	CSTB-3	T-9D
TDS280F32-3	●	28.0	32	40	84.0	88.0	109.0	59	168.0	1.3	0.7	WWMU08X408R-D*	CSTB-3	T-9D
TDS285F32-3	●	28.5	32	40	85.0	89.0	111.0	59	170.0	1.1	0.7	WWMU08X408R-D*	CSTB-3	T-9D
** TDSU1125F32-3	●	28.6	32	40	86.0	90.0	112.0	59	171.0	1.1	0.7	WWMU08X408R-D*	CSTB-3	T-9D
TDS290F32-3	●	29.0	32	40	87.0	91.0	112.0	59	171.0	1.1	0.7	WWMU08X408R-D*	CSTB-3	T-9D
TDS295F32-3	●	29.5	32	40	88.0	92.0	116.0	59	175.0	0.8	0.7	WWMU08X408R-D*	CSTB-3	T-9D
TDS300F32-3	●	30.0	32	40	90.0	94.0	117.0	59	176.0	0.8	0.8	WWMU08X408R-D*	CSTB-3	T-9D
TDS305F32-3	●	30.5	32	40	91.0	95.0	121.0	59	180.0	0.5	0.8	WWMU08X408R-D*	CSTB-3	T-9D
TDS310F32-3	●	31.0	32	40	93.0	97.0	121.0	59	180.0	0.5	0.8	WWMU08X408R-D*	CSTB-3	T-9D
** TDSU1250F32-3	●	31.8	32	40	95.0	99.0	124.0	59	183.0	0.2	0.8	WWMU08X408R-D*	CSTB-3	T-9D
TDS320F32-3	●	32.0	32	40	96.0	100.0	124.0	59	183.0	0.2	0.9	WWMU08X408R-D*	CSTB-3	T-9D
TDS330F40-3	●	33.0	40	50	99.0	103.0	128.0	69	197.0	1.7	1.3	WWMU09X510R-D*	CSTB-4	T-15D
TDS340F40-3	●	34.0	40	50	102.0	106.0	131.0	69	200.0	1.4	1.3	WWMU09X510R-D*	CSTB-4	T-15D
TDS350F40-3	●	35.0	40	50	105.0	109.0	135.0	69	204.0	1.2	1.3	WWMU09X510R-D*	CSTB-4	T-15D
TDS360F40-3	●	36.0	40	50	108.0	112.0	139.0	69	208.0	0.9	1.4	WWMU09X510R-D*	CSTB-4	T-15D
TDS370F40-3	●	37.0	40	50	111.0	115.0	142.0	69	211.0	0.7	1.4	WWMU09X510R-D*	CSTB-4	T-15D
TDS380F40-3	●	38.0	40	50	114.0	118.0	146.0	69	215.0	0.4	1.5	WWMU09X510R-D*	CSTB-4	T-15D
TDS390F40-3	●	39.0	40	50	117.0	121.0	149.0	69	218.0	2.2	1.6	WWMU11X512R-D*	CSTB-5	T-20D
TDS400F40-3	●	40.0	40	50	120.0	124.0	153.0	69	222.0	1.9	1.6	WWMU11X512R-D*	CSTB-5	T-20D
TDS410F40-3	●	41.0	40	50	123.0	127.0	157.0	69	226.0	1.7	1.7	WWMU11X512R-D*	CSTB-5	T-20D
TDS420F40-3	●	42.0	40	55	126.0	130.0	160.0	69	229.0	1.5	1.8	WWMU11X512R-D*	CSTB-5	T-20D
TDS430F40-3	●	43.0	40	55	129.0	133.0	164.0	69	233.0	1.3	1.8	WWMU11X512R-D*	CSTB-5	T-20D
TDS440F40-3	●	44.0	40	55	132.0	136.0	167.0	69	236.0	1.0	1.9	WWMU11X512R-D*	CSTB-5	T-20D
TDS450F40-3	●	45.0	40	55	135.0	139.0	172.0	69	241.0	0.7	2.0	WWMU11X512R-D*	CSTB-5	T-20D
TDS460F40-3	●	46.0	40	55	138.0	142.0	176.0	69	245.0	0.4	2.1	WWMU11X512R-D*	CSTB-5	T-20D
TDS470F40-3	●	47.0	40	55	141.0	145.0	179.0	69	248.0	2.6	2.2	WWMU13X512R-D*	CSTB-5	T-20D
TDS480F40-3	●	48.0	40	55	144.0	148.0	183.0	69	252.0	2.4	2.3	WWMU13X512R-D*	CSTB-5	T-20D
TDS490F40-3	●	49.0	40	55	147.0	151.0	186.0	69	255.0	2.2	2.3	WWMU13X512R-D*	CSTB-5	T-20D
TDS500F40-3	●	50.0	40	55	150.0	154.0	190.0	69	259.0	2.0	2.4	WWMU13X512R-D*	CSTB-5	T-20D
TDS510F40-3	●	51.0	40	55	153.0	157.0	194.0	69	263.0	1.7	2.5	WWMU13X512R-D*	CSTB-5	T-20D
TDS520F40-3	●	52.0	40	55	156.0	160.0	197.0	69	266.0	1.5	2.6	WWMU13X512R-D*	CSTB-5	T-20D
TDS530F40-3	●	53.0	40	55	159.0	163.0	201.0	69	270.0	1.3	2.7	WWMU13X512R-D*	CSTB-5	T-20D
TDS540F40-3	●	54.0	40	55	162.0	166.0	204.0	69	273.0	1.0	2.9	WWMU13X512R-D*	CSTB-5	T-20D

* For pre thread hole (mm)

$\phi D_c = 20.9$ mm: M24x3 / $\phi D_c = 23.9$ mm: M27x3 / $\phi D_c = 26.4$ mm: M30x3.5

● : Stocked items



** For inch size

$\phi D_c = 22.2$ mm = 0.875", $\phi D_c = 28.6$ mm = 1.125", $\phi D_c = 31.8$ mm = 1.250"

L/D = 4

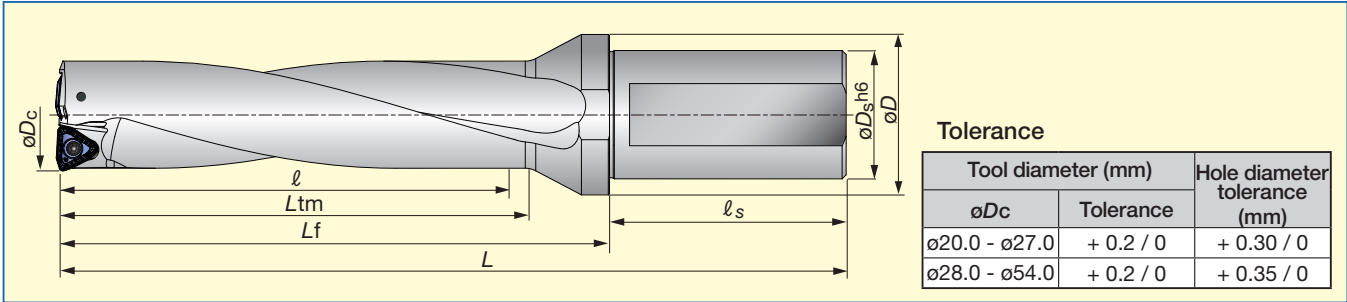
Machined hole diameter may change depending upon the rigidity of the machine tool or cutting conditions.



Designation	Stock	Dimensions (mm)								Max offset (Radius)	Weight (kg)	Applicable inserts	Clamping screw 	Torx driver 
		øDc	øDs	øD	ℓ	Ltm	Lf	ℓs	L					
TDS200F25-4	●	20.0	25	32	80	84.0	102.0	54	155.0	1.0	0.4	WWMU05X205R-D*	CSPB-2.2	IP-7D
TDS205F25-4	●	20.5	25	32	82	86.0	104.0	54	157.0	0.9	0.4	WWMU05X205R-D*	CSPB-2.2	IP-7D
TDS210F25-4	●	21.0	25	32	84	88.0	106.0	54	159.0	0.8	0.4	WWMU05X205R-D*	CSPB-2.2	IP-7D
TDS215F25-4	●	21.5	25	32	86	90.0	108.0	54	161.0	0.6	0.4	WWMU05X205R-D*	CSPB-2.2	IP-7D
TDS220F25-4	●	22.0	25	32	88	92.0	110.0	54	163.0	0.5	0.4	WWMU05X205R-D*	CSPB-2.2	IP-7D
TDS225F25-4	●	22.5	25	37	90	94.0	112.5	54	165.5	0.4	0.4	WWMU05X205R-D*	CSPB-2.2	IP-7D
TDS230F25-4	●	23.0	25	37	92	96.0	115.0	54	168.0	0.3	0.4	WWMU05X205R-D*	CSPB-2.2	IP-7D
TDS235F25-4	●	23.5	25	37	94	98.0	117.5	54	170.5	0.2	0.5	WWMU05X205R-D*	CSPB-2.2	IP-7D
TDS240F25-4	●	24.0	25	37	96	100.0	120.0	54	173.0	1.2	0.5	WWMU060306R-D*	CSPB-2.5	IP-8D
TDS245F25-4	●	24.5	25	37	98	102.0	122.5	54	175.5	1.0	0.5	WWMU060306R-D*	CSPB-2.5	IP-8D
TDS250F25-4	●	25.0	25	37	100	104.0	125.0	54	178.0	0.8	0.5	WWMU060306R-D*	CSPB-2.5	IP-8D
TDS255F25-4	●	25.5	25	37	102	106.0	127.0	54	180.0	0.6	0.6	WWMU060306R-D*	CSPB-2.5	IP-8D
TDS260F25-4	●	26.0	25	37	104	108.0	129.0	54	182.0	0.5	0.5	WWMU060306R-D*	CSPB-2.5	IP-8D
TDS270F32-4	●	27.0	32	40	108	112.0	133.0	59	191.0	0.3	0.7	WWMU060306R-D*	CSPB-2.5	IP-8D
TDS280F32-4	●	28.0	32	40	112	116.0	137.0	59	196.0	1.3	0.8	WWMU08X408R-D*	CSTB-3	T-9D
TDS290F32-4	●	29.0	32	40	116	120.0	141.0	59	200.0	1.1	0.8	WWMU08X408R-D*	CSTB-3	T-9D
TDS300F32-4	●	30.0	32	40	120	124.0	147.0	59	206.0	0.8	0.9	WWMU08X408R-D*	CSTB-3	T-9D
TDS310F32-4	●	31.0	32	40	124	128.0	152.0	59	211.0	0.5	0.9	WWMU08X408R-D*	CSTB-3	T-9D
TDS320F32-4	●	32.0	32	40	128	132.0	156.0	59	215.0	0.2	1.0	WWMU08X408R-D*	CSTB-3	T-9D
TDS330F40-4	●	33.0	40	50	132	136.0	161.0	69	230.0	1.7	1.4	WWMU09X510R-D*	CSTB-4	T-15D
TDS340F40-4	●	34.0	40	50	136	140.0	165.0	69	234.0	1.4	1.4	WWMU09X510R-D*	CSTB-4	T-15D
TDS350F40-4	●	35.0	40	50	140	144.0	170.0	69	239.0	1.2	1.4	WWMU09X510R-D*	CSTB-4	T-15D
TDS360F40-4	●	36.0	40	50	144	148.0	175.0	69	244.0	0.9	1.5	WWMU09X510R-D*	CSTB-4	T-15D
TDS370F40-4	●	37.0	40	50	148	152.0	179.0	69	248.0	0.7	1.5	WWMU09X510R-D*	CSTB-4	T-15D
TDS380F40-4	●	38.0	40	50	152	156.0	184.0	69	253.0	0.4	1.7	WWMU09X510R-D*	CSTB-4	T-15D
TDS390F40-4	●	39.0	40	50	156	160.0	188.5	69	257.5	2.2	1.8	WWMU11X512R-D*	CSTB-5	T-20D
TDS400F40-4	●	40.0	40	50	160	164.0	193.5	69	262.5	1.9	1.8	WWMU11X512R-D*	CSTB-5	T-20D
TDS410F40-4	●	41.0	40	50	164	168.0	198.5	69	267.5	1.7	1.9	WWMU11X512R-D*	CSTB-5	T-20D
TDS420F40-4	●	42.0	40	55	168	172.0	202.5	69	271.5	1.5	2.0	WWMU11X512R-D*	CSTB-5	T-20D
TDS430F40-4	●	43.0	40	55	172	176.0	207.5	69	276.5	1.3	2.0	WWMU11X512R-D*	CSTB-5	T-20D
TDS440F40-4	●	44.0	40	55	176	180.0	211.5	69	280.5	1.0	2.1	WWMU11X512R-D*	CSTB-5	T-20D
TDS450F40-4	●	45.0	40	55	180	184.0	217.5	69	286.5	0.7	2.3	WWMU11X512R-D*	CSTB-5	T-20D
TDS460F40-4	●	46.0	40	55	184	188.0	222.5	69	291.5	0.4	2.4	WWMU11X512R-D*	CSTB-5	T-20D
TDS470F40-4	●	47.0	40	55	188	192.0	226.5	69	295.5	2.6	2.5	WWMU13X512R-D*	CSTB-5	T-20D
TDS480F40-4	●	48.0	40	55	192	196.0	231.5	69	300.5	2.4	2.7	WWMU13X512R-D*	CSTB-5	T-20D
TDS490F40-4	●	49.0	40	55	196	200.0	235.5	69	304.5	2.2	2.7	WWMU13X512R-D*	CSTB-5	T-20D
TDS500F40-4	●	50.0	40	55	200	204.0	240.5	69	309.5	2.0	2.8	WWMU13X512R-D*	CSTB-5	T-20D
TDS510F40-4	●	51.0	40	55	204	208.0	245.5	69	314.5	1.7	2.9	WWMU13X512R-D*	CSTB-5	T-20D
TDS520F40-4	●	52.0	40	55	208	212.0	249.5	69	318.5	1.5	3.0	WWMU13X512R-D*	CSTB-5	T-20D
TDS530F40-4	●	53.0	40	55	212	216.0	254.5	69	323.5	1.3	3.1	WWMU13X512R-D*	CSTB-5	T-20D
TDS540F40-4	●	54.0	40	55	216	220.0	258.5	69	327.5	1.0	3.4	WWMU13X512R-D*	CSTB-5	T-20D

● : Stocked items

● Inserts

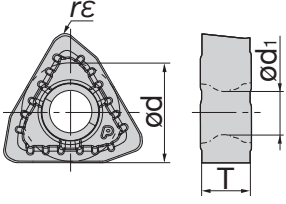

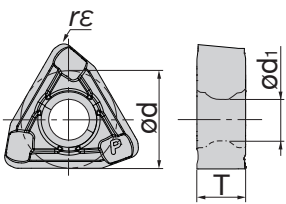

DJ chipbreaker 	Designation	Stocked grades		Dimensions (mm)				Applicable drill diameters øDc (mm)
		PREMIUMTEC		ød	T	ød1	rε	
		AH9030	AH3135					
WWMU05X205R-DJ	●	●	5.8	2.4	2.5	0.5	ø20.0 - ø23.5	
WWMU060306R-DJ	●	●	6.7	2.9	3	0.6	ø23.9 - ø27.0	
WWMU08X408R-DJ	●	●	8.0	3.9	3.4	0.8	ø28.0 - ø32.0	
WWMU09X510R-DJ	●	●	9.7	4.9	4.4	1.0	ø33.0 - ø38.0	
WWMU11X512R-DJ	●	●	11.3	5.7	5.5	1.2	ø39.0 - ø46.0	
WWMU13X512R-DJ	●	●	13.0	5.7	5.5	1.2	ø47.0 - ø54.0	

DS chipbreaker 	Designation	Stocked grades		Dimensions (mm)				Applicable drill diameters øDc (mm)
		PREMIUMTEC		ød	T	ød1	rε	
		AH6030						
WWMU05X205R-DS	●	●	5.8	2.4	2.5	0.5	ø20.0 - ø23.5	
WWMU060306R-DS	●	●	6.7	2.9	3	0.6	ø23.9 - ø27.0	
WWMU08X408R-DS	●	●	8.0	3.9	3.4	0.8	ø28.0 - ø32.0	
WWMU09X510R-DS	●	●	9.7	4.9	4.4	1.0	ø33.0 - ø38.0	
WWMU11X512R-DS	●	●	11.3	5.7	5.5	1.2	ø39.0 - ø46.0	
WWMU13X512R-DS	●	●	13.0	5.7	5.5	1.2	ø47.0 - ø54.0	

● : Stocked items

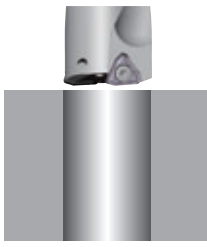
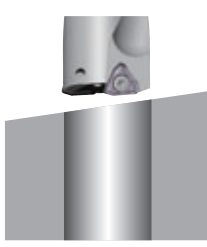
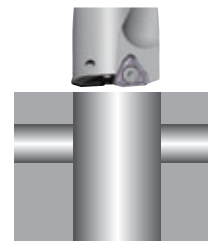
● Application range

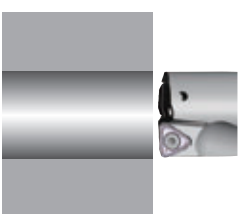
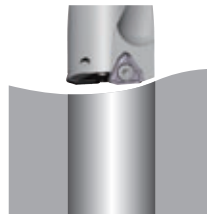
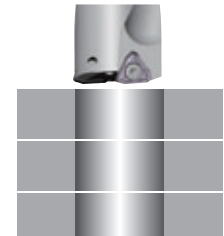
In case of Interrupted cutting, feed should be decreased.

Feed f (mm/rev)	Upper table	0.05	0.05	0.05
Application	OK Plane surface 	OK Slant surface 	OK Cross hole 	OK Plunging 
Feed f (mm/rev)	0.1	0.05	Disapprove	Disapprove
Application	OK Boring 	OK Round surface 	X Stacked plate 	X Back boring 

Chamfering ring "TDXCF Series"

The TDXCF Series with the TungSix-Drill performs both drilling and chamfering at the same time, reducing machining processes and machining time.



● Features

- High productivity with two inserts.
- Optimum space between the drill body and chamfering inserts prevents cutting edges from fracture.

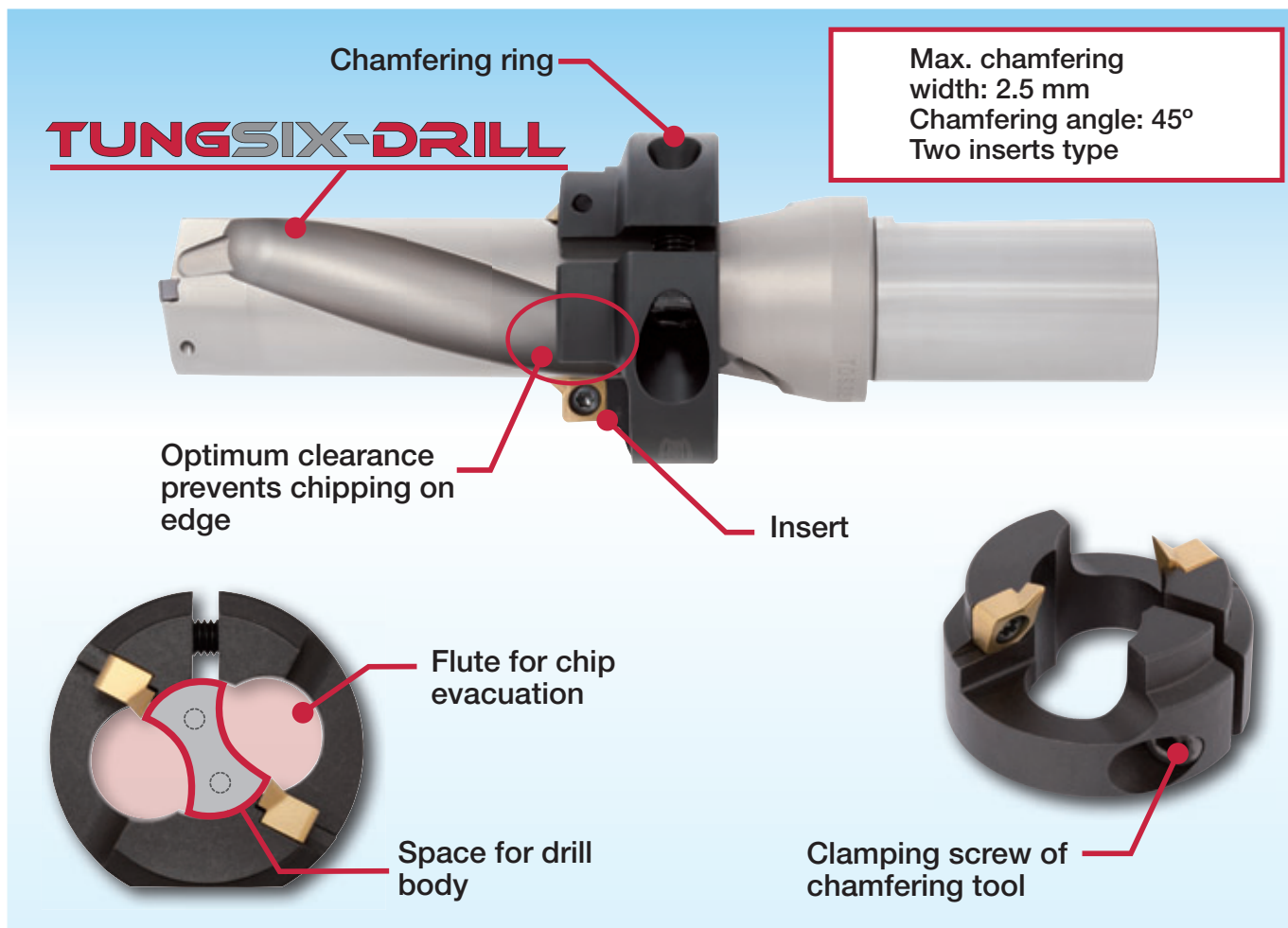

- Insert grade is GH130 with TiCNO coating for steels.
- Suitable for machining steel, stainless steels and cast irons.

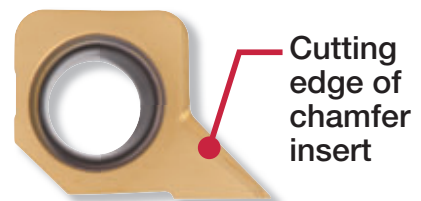

● Chamfering tool insert & part list

Designation	Insert	Grade	Insert clamping screw	Torque (N·m)	Ring clamping screw	Torque (N·m)	Wrench for insert	Wrench for ring
		GH130						
TDXCF280L30 TDXCF540L30	XHGX090700R-45A	●	CSPB-4S	3.5	CM8X1.25X20-A	8.0	T-15D	P-5

● : Stocked items

● Chamfering ring (TDXCF Series)

For flat cotter

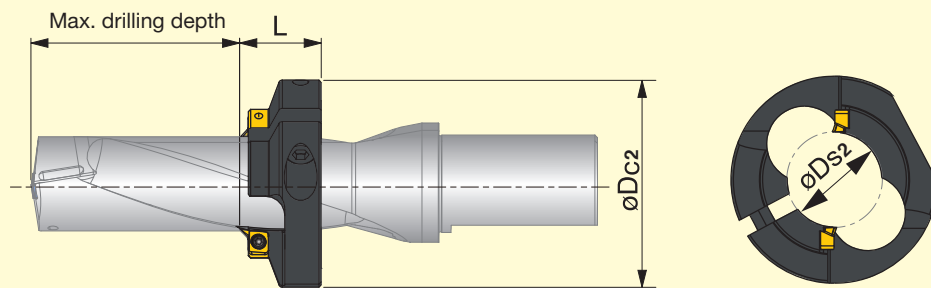

Designation	Stock	Dimensions (mm)				Application drill	Max. drilling depth (mm)		
		øDs2	øDc2	L	Drill dia. øDc		L/D = 2	L/D = 3	L/D = 4
TDXCF200L25	●	19.10	49.00	25	19.5	TDS200F25-*	15.5	35.5	62.5
TDXCF210L25	●	20.10	49.00	25	20.5	TDS205F25-*	16.5	37.0	64.6
TDXCF210L25	●	20.10	49.00	25	20.9	TDS209F25-*	-	38.5	-
TDXCF210L25	●	20.10	49.00	25	21.0	TDS210F25-*	17.5	38.5	66.5
TDXCF220L25	●	21.10	49.00	25	21.5	TDS215F25-*	18.5	40.0	68.6
TDXCF220L25	●	21.10	49.00	25	22.0	TDS220F25-*	19.5	41.5	70.5
TDXCF230L25	●	22.10	49.00	25	22.5	TDS225F25-*	20.5	43.0	72.6
TDXCF230L25	●	22.10	49.00	25	23.0	TDS230F25-*	21.5	44.5	74.5
TDXCF240L25	●	23.10	49.00	25	23.5	TDS235F25-*	22.5	46.0	76.6
TDXCF240L25	●	23.10	49.00	25	23.9	TDS239F25-*	-	47.5	-
TDXCF240L25	●	23.10	49.00	25	24.0	TDS240F25-*	23.5	47.5	78.5
TDXCF250L25	●	23.95	49.00	25	24.5	TDS245F25-*	24.5	49.0	80.6
TDXCF250L25	●	23.95	49.00	25	25.0	TDS250F25-*	25.5	50.5	82.5
TDXCF260L30	●	24.95	64.00	30	25.5	TDS255F25-*	21.5	47.0	79.6
TDXCF260L30	●	24.95	64.00	30	26.0	TDS260F25-*	22.5	48.5	81.5
TDXCF270L30	●	25.90	64.00	30	26.4	TDS264F32-*	-	50.0	-
TDXCF270L30	●	25.90	64.00	30	26.5	TDS265F32-*	-	50.0	-
TDXCF270L30	●	25.90	64.00	30	27.0	TDS270F32-*	24.5	51.5	85.5
TDXCF280L30	●	26.90	64.00	30	28.0	TDS280F32-*	26.5	54.5	89.5
TDXCF290L30	●	27.90	64.00	30	29.0	TDS290F32-*	28.5	57.5	93.5
TDXCF300L30	●	28.90	64.00	30	30.0	TDS300F32-*	30.5	60.5	97.5
TDXCF310L30	●	29.90	64.00	30	31.0	TDS310F32-*	32.5	63.5	101.5
TDXCF320L30	●	30.90	64.00	30	32.0	TDS320F32-*	34.5	66.5	105.5
TDXCF330L30		31.80	64.00	30	33.0	TDS330F40-*	36.5	69.5	109.5
TDXCF340L30		32.80	64.00	30	34.0	TDS340F40-*	38.5	72.5	113.5
TDXCF350L30		33.80	64.00	30	35.0	TDS350F40-*	40.5	75.5	117.5
TDXCF360L30		34.80	85.00	30	36.0	TDS360F40-*	42.5	78.5	122.5
TDXCF370L30		35.80	85.00	30	37.0	TDS370F40-*	44.5	81.5	125.5
TDXCF380L30		36.80	85.00	30	38.0	TDS380F40-*	46.5	84.5	129.5
TDXCF390L30		37.80	85.00	30	39.0	TDS390F40-*	48.5	87.5	133.5
TDXCF400L30		38.80	85.00	30	40.0	TDS400F40-*	50.5	90.5	137.5
TDXCF410L30		39.80	85.00	30	41.0	TDS410F40-*	52.5	93.5	141.5
TDXCF420L30		40.60	85.00	30	42.0	TDS420F40-*	54.5	96.5	145.5
TDXCF430L30		41.60	85.00	30	43.0	TDS430F40-*	56.5	99.5	149.5
TDXCF440L30		42.60	85.00	30	44.0	TDS440F40-*	58.5	102.5	153.5
TDXCF450L30		43.60	85.00	30	45.0	TDS450F40-*	60.5	105.5	157.5
TDXCF460L30		44.60	85.00	30	46.0	TDS460F40-*	62.5	108.5	162.5
TDXCF470L30		45.60	85.00	30	47.0	TDS470F40-*	64.5	111.5	165.5
TDXCF480L30		46.60	85.00	30	48.0	TDS480F40-*	66.5	114.5	169.5
TDXCF490L30		47.60	85.00	30	49.0	TDS490F40-*	68.5	117.5	173.5
TDXCF500L30		48.60	85.00	30	50.0	TDS500F40-*	70.5	120.5	177.5
TDXCF510L30		49.60	85.00	30	51.0	TDS510F40-*	72.5	123.5	181.5
TDXCF520L30		50.60	85.00	30	52.0	TDS520F40-*	74.5	126.5	185.5
TDXCF530L30		51.60	85.00	30	53.0	TDS530F40-*	76.5	129.5	189.5
TDXCF540L30		52.60	85.00	30	54.0	TDS540F40-*	78.5	132.5	193.5

● : Stocked items

- Points of caution when mounting the chamfering ring on drill body

- ① Place the ring on the drill body and match the ring flute with the drill flute. Temporarily clamp the ring on the body by lightly tightening the ring screw. Place the inserts on the ring and lightly tighten the insert screws.
- ② Adjust the ring to the right position with a presetter, height gauge or vernier caliper.
- ③ Securely tighten the ring screw and then the insert screw.

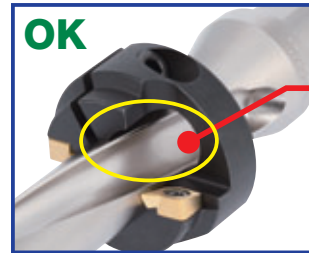

Match the ring flute with the drill flute

(Insert will be automatically set to the right position)

The ring flute does not match the drill flute



Insert is in the wrong position due to incorrectly placed ring

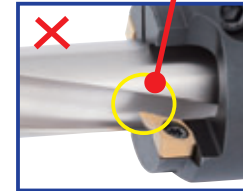

TUNGBORE Adjustable drilling diameter holder

Enables diameter of TungdrillTwisted to adjust easily

● Specification

BT / DIN69871 type

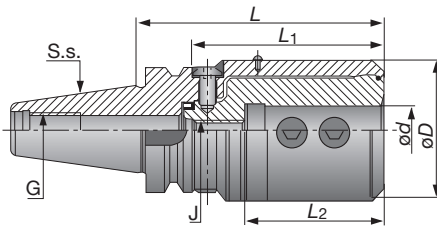

HSK type

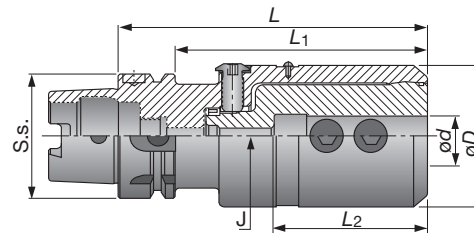

Designation	Stock	Dimensions (mm)								Tool Dia. (mm)
		S.s.	ød	øD	L	L1	L2	J	G	
TUNGBORE-BT40EM25ADB		40	25.00	72.0	123.50	96.5	71.0	M10	M16	ø20.0 - ø26.0
TUNGBORE-BT40EM32ADB		40	32.00	72.0	123.50	96.5	71.0	M10	M16	ø27.0 - ø32.0
TUNGBORE-BT40EM40ADB		40	40.00	72.0	123.50	96.5	71.0	M10	M16	ø33.0 - ø54.0
TUNGBORE-BT50EM20ADB		50	20.00	72.0	134.50	96.5	71.0	M10	M24	ø12.5 - ø17.0
TUNGBORE-BT50EM25ADB		50	25.00	72.0	134.50	96.5	71.0	M10	M24	ø17.5 - ø26.0
TUNGBORE-BT50EM32ADB		50	32.00	72.0	134.50	96.5	71.0	M10	M24	ø27.0 - ø32.0
TUNGBORE-BT50EM40ADB		50	40.00	72.0	134.50	96.5	71.0	M10	M24	ø33.0 - ø54.0
TUNGBORE-SKA40EM20ADB		40	20	72.0	135.6	116.5	71.0	M10	M16	ø12.5 - ø17.0
TUNGBORE-SKA40EM25ADB		40	25	72.0	135.6	116.5	71.0	M10	M16	ø17.5 - ø26.0
TUNGBORE-SKA40EM32ADB		40	32	72.0	135.6	116.5	71.0	M10	M16	ø27.0 - ø32.0
TUNGBORE-SKA40EM40ADB		40	40	72.0	135.6	116.5	71.0	M10	M16	ø33.0 - ø54.0
TUNGBORE-SKA50EM20ADB		50	20	72.0	115.6	96.5	71.0	M10	M24	ø12.5 - ø17.0
TUNGBORE-SKA50EM25ADB		50	25	72.0	115.6	96.5	71.0	M10	M24	ø17.5 - ø26.0
TUNGBORE-SKA50EM32ADB		50	32	72.0	115.6	96.5	71.0	M10	M24	ø27.0 - ø32.0
TUNGBORE-SKA50EM40ADB		50	40	72.0	115.6	96.5	71.0	M10	M24	ø33.0 - ø54.0
TUNGBOREHSKA63EM25		63	25.00	72.0	142.00	116.0	71.0	M10	-	ø17.5 - ø26.0
TUNGBOREHSKA63EM32		63	32.00	72.0	142.00	116.0	71.0	M10	-	ø27.0 - ø32.0
TUNGBOREHSKA63EM40		63	40.00	72.0	142.00	116.0	71.0	M10	-	ø33.0 - ø54.0

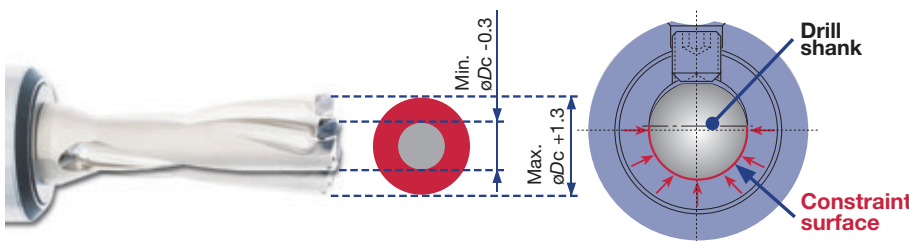

The bore section is actually made from two shifted circular sections. The clamping screw pushes the drill shank through a narrow opening, forcing elastic deformation of the holder. Contact is made around more than 180°, providing a high clamping force.

Tool diameter øDc (mm)	Adjustable range (mm)	
	Min. dia. ø	Max. dia. ø
20.0	20.0	21.3
20.5	20.5	21.8
20.9	20.9	22.2
21.0	21.0	22.3
21.5	21.5	22.7
22.0	22.0	23.0
22.5	22.5	23.3
23.0	23.0	23.6
23.5	23.5	23.9
23.9	23.9	25.2
24.0	24.0	25.3
24.5	24.5	25.8
25.0	25.0	26.3
25.5	25.5	26.7
26.0	26.0	27.0
26.4	26.4	27.2
26.5	26.5	27.3
27.0	27.0	27.6
28.0	28.0	29.3
29.0	29.0	30.3
30.0	30.0	31.3
31.0	31.0	32.0
32.0	32.0	32.4

Tool diameter øDc (mm)	Adjustable range (mm)	
	Min. dia. ø	Max. dia. ø
33	33	34.3
34	34	35.3
35	35	36.3
36	36	37.3
37	37	38.3
38	38	38.8
39	39	40.3
40	40	41.3
41	41	42.3
42	42	43.3
43	43	44.3
44	44	45.3
45	45	46.3
46	46	46.8
47	47	48.3
48	48	49.3
49	49	50.3
50	50	51.3
51	51	52.3
52	52	53.3
53	53	54.3
54	54	55.3

Regarding adjustment, please refer to the operating instructions in the TungBore leaflet for the TungHold (No. 389-E)

EZ sleeve (Eccentric sleeves for TungSix-Drill)

The function of EZ sleeves

Adjusting the hole diameter when drilling

Adjusting the hole diameter in tool-rotating applications.

By using EZ sleeve, the hole diameter can be adjusted in the range from **+0.6 mm to -0.2 mm**.



Adjusting cutting edge height on lathe

Adjusting the cutting edge height in rotating work applications.

By using EZ sleeve, the cutting edge height can be adjusted in the range from **+0.3 mm to -0.2 mm**. That reduces troubles caused by improper cutting-edge height.



Scale for adjusting the hole diameter in milling machine (Periphery of sleeve)

Scale for adjusting cutting edge height in turning (Front face of sleeve)

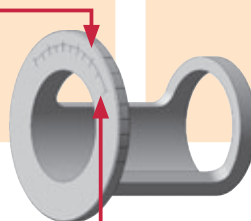

Setting of EZ sleeve

Adjusting the hole diameter on M/C

Set the EZ sleeve between the drill shank and the holder. Align the scale on the periphery of EZ sleeve with the center of the flat on drill flange.

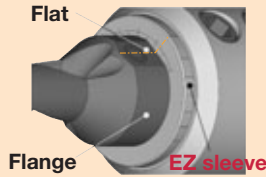

In the figure shown on right, the sleeve is set and the hole diameter will be increased by 0.4 mm.

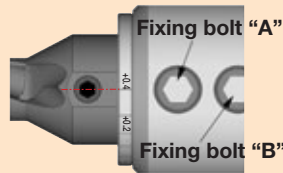

Adjusting cutting edge height on lathe

Set the EZ sleeve between the drill shank and the toolblock. Align the scale on the front face of the EZ sleeve with the center of the flat on drill flange.

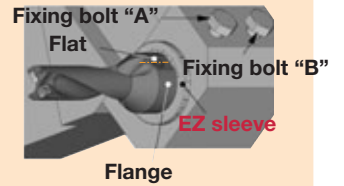

In the figure shown on right, the sleeve is set and the center of the drill will shift by 0.1 mm to the plus (+) direction.

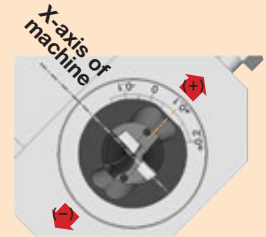

When rotating EZ sleeve, fixing bolts "A" and "B" have to be loosened. After setting the hole diameter, fix the drill body with bolt "A". Then lightly tighten the bolt "B" to fix EZ sleeve. If the bolt "B" is over tightened, EZ sleeve may be damaged.

Cautious points

- Cannot be used for collet chuck holders.
- For adjustments over $L/D = 4$, please reduce feed rate.
- For smaller adjustment, the drill itself will interfere with the hole diameter. It is recommended that hole diameter should be adjusted to a larger diameter than the drill diameter.

- Specifications

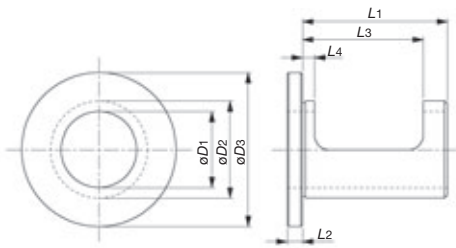

Sleeve Designation	Stock	Dimensions (mm)								Adjusting range of finishing diameter	Adjusting range of cutting edge height
		øD1	øD2	øD3	L1	L2	L3	L4			
EZ2025	●	20	25	46	49	5	32.5	4	+0.4 ~ -0.2	+0.2 ~ -0.15	
EZ2532	●	25	32	51	52	5	38	4	+0.4 ~ -0.2	+0.2 ~ -0.15	
EZ3240	●	32	40	54	62	5	43	4	+0.4 ~ -0.2	+0.2 ~ -0.15	
EZ4050	●	40	50	69	63	5	55	4	+0.6 ~ -0.2	+0.3 ~ -0.2	

Note: Select the sleeve so that the D1 of the sleeve will be same as the diameter of the drill shank. ● : Stocked items

Cautious points

Using TungSix-Drill

- Ensure that the drilling machine to be used has sufficient rigidity and motor output.
- Not recommended for drilling stacked plates.
- Be sure to carry out proper alignment when drilling is to be performed on a rotating workpiece.

Cutting fluid

- Be sure to supply cutting fluid through the tool.
- A water soluble emulsifiable type cutting fluid should be used.
- Fluid pressure of 1 MPa or higher and fluid quantity of 7 l/min or more are essential. For 4D and 5D type, a fluid pressure of 1.5 MPa or higher and fluid quantity of 10 l/min or more is recommended.

Cautious points for setting inserts

- Before installing the insert in the drill body, remove all foreign matter from the insert pocket.
- When clamping and unclamping the insert, the center-line of the wrench should be aligned with the center-line of the screw. Misalignment may result in deformation of the socket of the screw head or the tip of the wrench.
- When installing the insert, eliminate all play between the insert pocket and the bottom face of the insert.
- Replace the screw before it is excessively deformed or worn out by long term use.

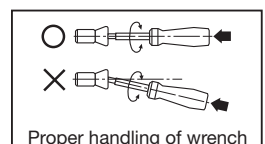

● Use of TungSix-Drill on lathes

Setting of drill body is an important point for stable machining

Mounting the drill on turret (tool post)

- When mounting drill body, the cutting edges should be parallel to the X-axis of the machine.
- Usually, the drill body is mounted in the direction that the peripheral insert can be seen by the operator.
- As the cotter on shank is parallel to the cutting edges, the clamping of the drill ensures that the cutting edges are parallel to the X-axis of the machine.

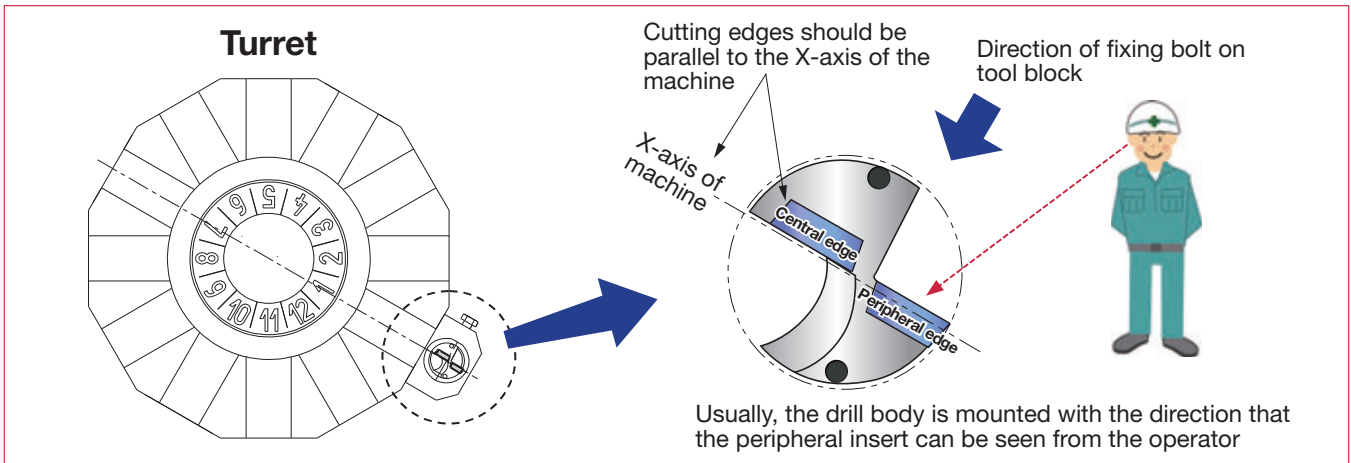

Checking of cutting edge height

- The cutting edge height is an important factor for stable machining.
- The cutting edge of central insert should be 0.2 mm lower than the rotating axis of machine.
- For checking the difference between rotating center and the tool block, please use a reference bar from ground solid bar. (Fig. 2)
- In this case, the checking of the center height should be measured at the same position as the overhang length of the drill required.
- When there isn't a reference bar, the ground part of a boring bar can be used as a substitute.

Fig. 1

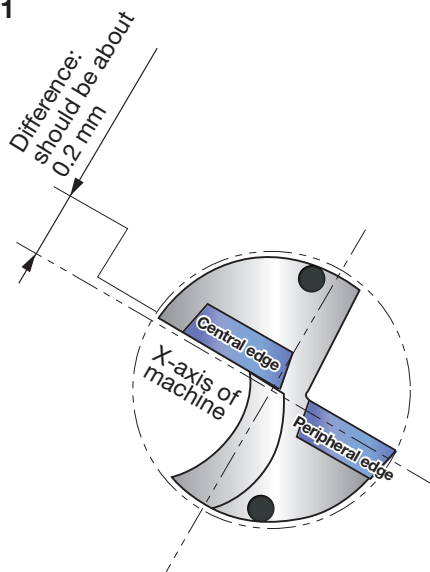

If the condition of cutting edge height is not good, basically the height should be set by adjusting the turret.
But, a simple method is shown in the next page.

Fig. 2

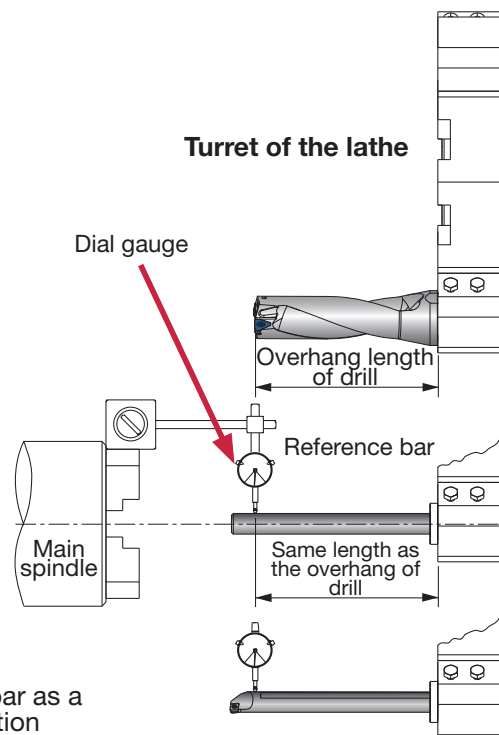

Checking of setting conditions by trial cutting

- After mounting the drill body, the tool center should be checked by trial cutting before production.
- When the drill body is properly set, a core with about $\phi 0.5$ mm diameter is left on the bottom of hole.
- If there is no core, the drill is “above center”. If the core diameter is larger than $\phi 1$ mm, it is “excessively below center”. In these cases, the cutting edge height has to be checked again.
- When trial cutting, the feed should be 0.1 mm/rev or less, drilling depth should be up to 10 mm.

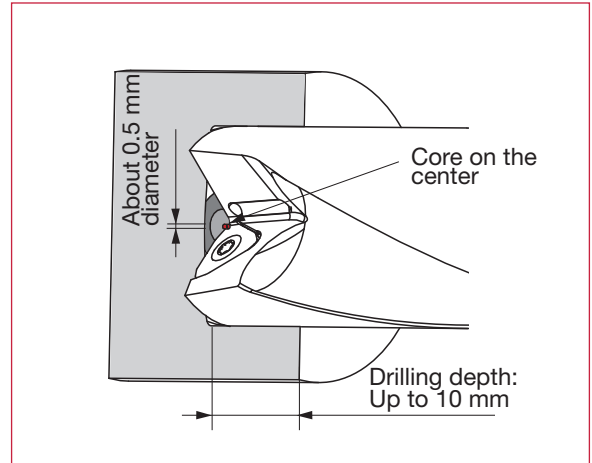

Adjusting of cutting edge height

When the condition of the cutting edge height is incorrect, the height should be adjusted with the following methods.

① In the case of “above-center”

When machining with such condition, the central cutting edge may be easily chipped. So this condition has to be rectified.

Solution #1: Change the mounting direction.

Solution #2: Rotate drill body 180°

In #2, additional cotter is required on the opposite side.

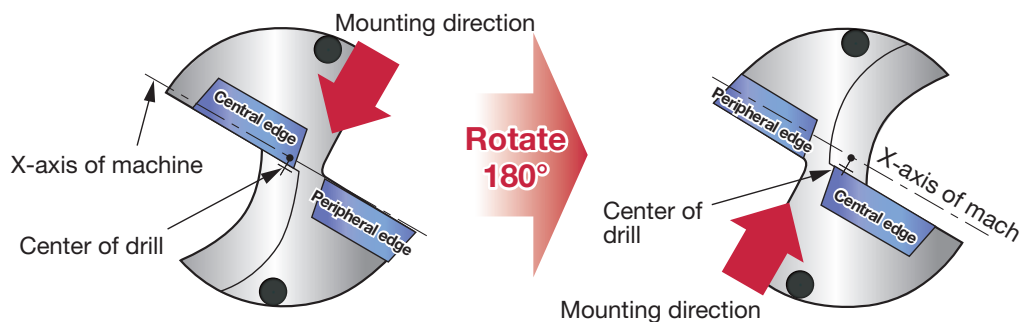

② In the case of “slightly above-center” (about 0.05 mm)

In this case, shifting the mounting position to another position may improve the condition.

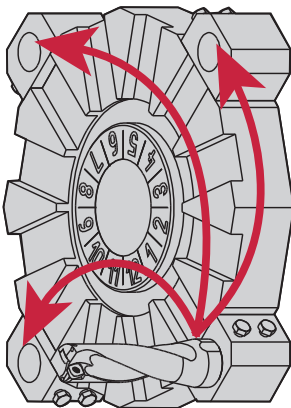

③ In the case of “excessive below-center” (0.2 mm or more)

When this occurs, the large diameter of the core remains and heavy vibration may occur. To improve this situation: Use EZ sleeve (the eccentric sleeve) and adjust the cutting edge height to correct value. Information on EZ sleeve, is on page 14.

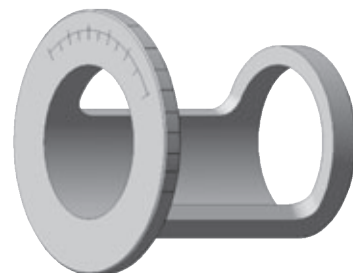

A larger hole than the drill diameter can be machined!

● Drilling with offset

- When drilling on the lathe, the hole diameter can be adjusted by offsetting the drill body along the X-axis of machine.
- When drilling with offset, the drill body must be correctly mounted with cutting edges parallel to the X-axis of the machine. "Mounting the drill on the turret" can be viewed on previous page.

Interferences

Offsetting direction to achieve smaller diameters

Central edge
Peripheral edge
Offset value must be less than 0.1 mm.

X-axis of machine

Direction of decreased diameters

Direction to achieve larger diameters

Offset value (+) is depend on the each drill body.

Offsetting direction to achieve larger diameters

Hole diameter machined with offset are roughly calculated as following.

Drilled diameter = Drill diameter + offset value x 2

Example:

Drill diameter: $\varnothing 20$ mm

Offset value: 0.2 mm

Drilled hole diameter = $20 + 0.2 \times 2 = \varnothing 20.4$ mm

Note: Each drill depending on the cutting balance, insert tolerance, and 4D machines different size of hole. This deviation should be considered while deciding the offset value.

Shapes of hole bottom



Un-evenness of the hole-bottom face when machined with TungSix-Drill is smaller than with HSS drills!

The shape of the hole bottom machined with TungSix-Drill is closer to flat compared with those machined with HSS drills.

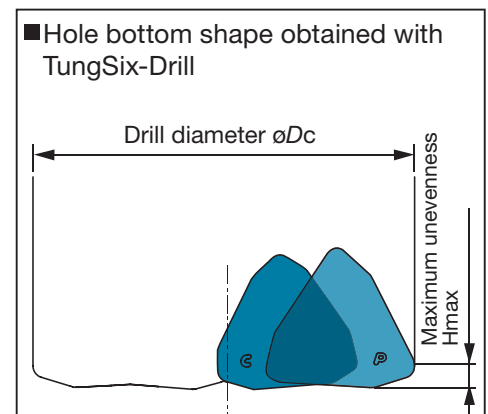
Drill diameter $\varnothing D_c$ (mm)	$\varnothing 20.0 - 23.5$	$\varnothing 23.6 - 27.4$	$\varnothing 27.5 - 32.9$	$\varnothing 33.0 - 33.9$	$\varnothing 39.0 - 46.9$	$\varnothing 47.0 - 54.5$
Insert	WWMU05...	WWMU06...	WWMU08...	WWMU09...	WWMU11...	WWMU13...
Hmax (mm)	1.2	1.4	1.8	2.1	2.5	2.7

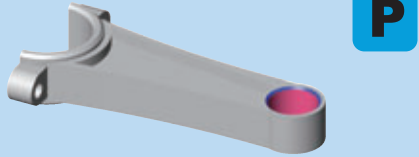

Practical examples

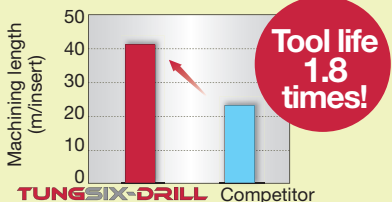
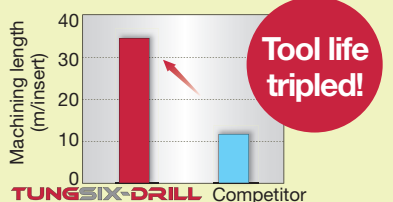
Workpiece type		Connecting rod	Housing
Drill		TDS200F25-2, $\phi D_c = 20$ mm	TDS420F40-2, $\phi D_c = 42$ mm
Insert		WWMU05X205R-DJ	WWMU11X512R-DJ
Grade		AH9030	AH9030
Workpiece material		S55C / C55	FCD450 / GGG45
			
Cutting conditions	Cutting speed: V_c (m/min)	200	120
	Feed: f (mm/rev)	0.15	0.2
	Feed speed: V_f (mm/min)	477	180
	Drilling depth: H (mm)	30	80
	Machine	Vertical M/C, BT40	NC lathe
Coolant		Wet	Wet
Results		 <p>AH9030 achieves longer tool life even when machining with external coolant supply, due to the high oxidation resistance.</p>	 <p>Tough cutting edge prevents chipping and edge fracture, even when interrupted machining. Increasing in tool life and higher number of insert corners drastically reduce machining cost.</p>

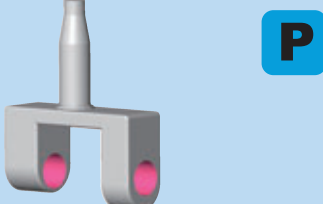
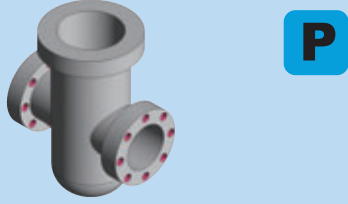
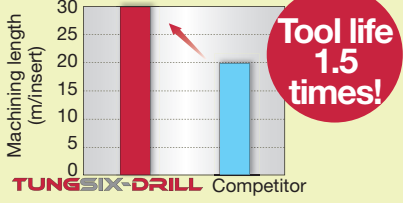
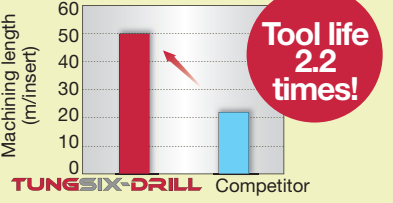
Workpiece type		Knuckle	Valve
Drill		TDS500F40-3, $\phi D_c = 50$ mm	TDS280F32-2, $\phi D_c = 28$ mm
Insert		WWMU13X512R-DJ	WWMU08X408R-DJ
Grade		AH9030	AH9030
Workpiece material		SCM440 / 42CrMo4	Alloy steel
			
Cutting conditions	Cutting speed: V_c (m/min)	160	180
	Feed: f (mm/rev)	0.11	0.18
	Feed speed: V_f (mm/min)	112	369
	Drilling depth: H (mm)	80, 65	50
	Machine	Horizontal M/C, BT50	Horizontal M/C, BT40
Coolant		Wet	Wet
Results		 <p>The machining of TungSix-Drill is highly stable without chattering due to lower cutting forces. No sudden fracture and 6 corners of insert reduce the machining cost.</p>	 <p>Improved tool life per corner leads to reduction of insert consumption. DJ chipbreaker allows excellent chip control and stable machining without vibration.</p>

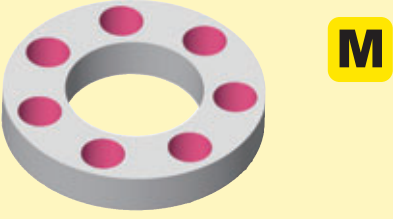
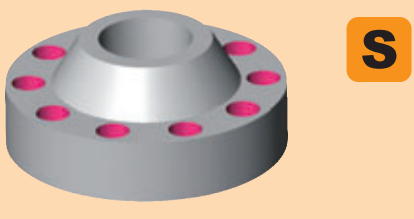
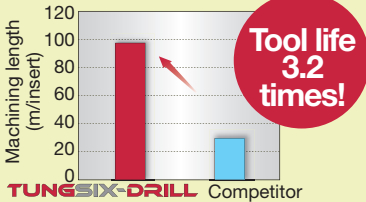
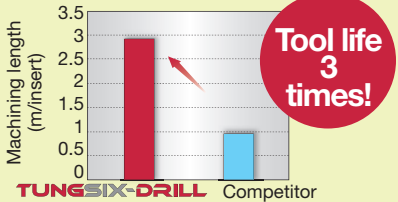
Workpiece type		Flange	Flange
Drill		TDS290F32-2, $\phi D_c = 29$ mm	TDS350F40-3, $\phi D_c = 35$ mm
Insert		WWMU08X408R-DS	WWMU09X510R-DS
Grade		AH6030	AH6030
Workpiece material		SUS304 / X5CrNi18-9	Inconel 625
			
Cutting conditions	Cutting speed: V_c (m/min)	140	40
	Feed: f (mm/rev)	0.075	0.06
	Feed speed: V_f (mm/min)	120	22
	Drilling depth: H (mm)	29	60
	Machine	Vertical M/C, BT50	Vertical M/C, BT50
Coolant		Wet	Wet
Results		 <p>The DS chipbreaker creates well controlled chips and the AH6030 provides longer tool life with improved chipping resistance.</p>	 <p>AH6030 with high reliability allows longer tool life. When machining super alloys such as Inconel, inserts with higher number of corners are very effective for reducing tool cost.</p>

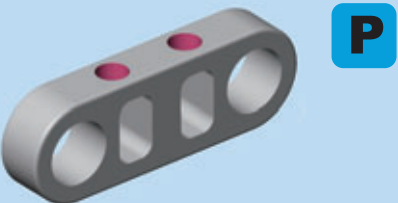
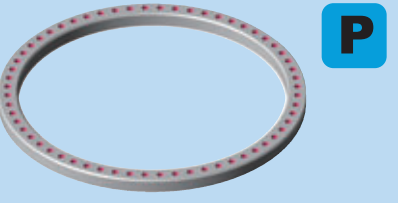
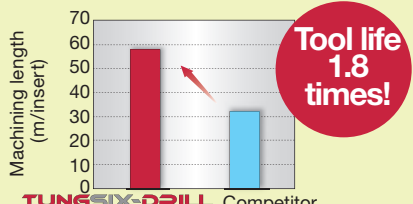
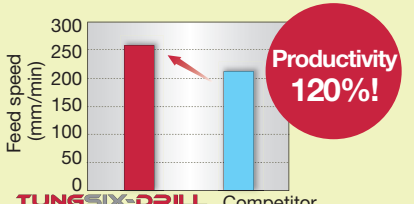
Workpiece type		Link	Slewing ring
Drill		TDS240F25-3, $\phi D_c = 24$ mm	TDS330F40-4, $\phi D_c = 33$ mm
Insert		WWMU060306R-DJ	WWMU09X510R-DJ
Grade		AH9030	AH9030
Workpiece material		SCM440 / 42CrMo4	SCM440 / 42CrMo4
			
Cutting conditions	Cutting speed: V_c (m/min)	130	180
	Feed: f (mm/rev)	0.1	0.15
	Feed speed: V_f (mm/min)	170	260
	Drilling depth: H (mm)	40	100
	Machine	Vertical M/C, BT40	Vertical M/C, BT50
Coolant		Wet	Wet
Results		 <p>Tough cutting edges prevents chipping even in interrupted drilling condition and provides longer tool life.</p>	 <p>Due to high rigidity, TungSix-Drill can machine without chattering even at higher cutting speed than competitor. Increased number of cutting edge and higher productivity drastically reduces the machining cost.</p>

Tungaloy Corporation (Head office)

11-1 Yoshima-Kogyodanchi
Iwaki-city, Fukushima, 970-1144 Japan
Phone: +81-246-36-8501
Fax: +81-246-36-8542
www.tungaloy.co.jp

Tungaloy America, Inc.

3726 N Ventura Drive
Arlington Heights, IL 60004, U.S.A.
Phone: +1-888-554-8394
Fax: +1-888-554-8392
www.tungaloyamerica.com

Tungaloy Canada

432 Elgin St. Unit 3
Brantford, Ontario N3S 7P7, Canada
Phone: +1-519-758-5779
Fax: +1-519-758-5791
www.tungaloy.co.jp/ca

Tungaloy de Mexico S.A.

C Los Arellano 113,
Parque Industrial Siglo XXI
Aguascalientes, AGS, Mexico 20290
Phone: +52-449-929-5410
Fax: +52-449-929-5411
www.tungaloy.co.jp/mx

Tungaloy do Brasil Ltda.

Avd. Independencia N4158 Residencial Flora
13280-000 Vinhedo, São Paulo, Brasil
Phone: +55-19-38262757
Fax: +55-19-38262757
www.tungaloy.com/br

Tungaloy Germany GmbH

An der Alten Ziegelei 1
D-40789 Monheim, Germany
Phone: +49-2173-90420-0
Fax: +49-2173-90420-19
www.tungaloy.de

Tungaloy France S.A.S.

ZA Courtaboeuf - Le Rio
1 rue de la Terre de feu
F-91952 Courtaboeuf Cedex, France
Phone: +33-1-6486-4300
Fax: +33-1-6907-7817
www.tungaloy.fr

Tungaloy Italia S.r.l.

Via E. Andolfato 10
I-20126 Milano, Italy
Phone: +39-02-252012-1
Fax: +39-02-252012-65
www.tungaloy.it

Tungaloy Czech s.r.o.

Turanka 115
CZ-627 00 Brno, Czech Republic
Phone: +420-532 123 391
Fax: +420-532 123 392
www.tungaloy.cz

Tungaloy Ibérica S.L.

C/Miquel Servet, 43B, Nau 7
Pol. Ind. Bufalvent
ES-08243 Manresa (BCN), Spain
Phone: +34 93 113 1360
Fax: +34 93 876 2798
www.tungaloy.es

Tungaloy Scandinavia AB

Bultgatan 38
442 40 Kungälv, Sweden
Phone: +46-462119200
www.tungaloy.se

Tungaloy Rus, LLC

Andropova avenue, h.18/7,
11 floor, office 3, 115432,
Moscow, Russia
Phone: +7-499-683-01-80
Fax: +7-499-683-01-81
www.tungaloy.co.jp/ru

Tungaloy East LLC

620075, Russian Federation, Sverdlovsk
Region, Ekaterinburg, Mamina-Sibiryaka str.,
bldg. 101, room 202
Phone: +7-343-286-48-23/24
Fax: +7-912-284-91-69
www.tungaloy.co.jp/rue

Tungaloy Polska Sp. z o.o.

ul. Genewska 24
03-963 Warszawa, Poland
Phone: +48-22-617-0890
Fax: +48-22-617-0890
www.tungaloy.co.jp/pl

Tungaloy U.K. Ltd

The Technology Centre,
Wolverhampton Science Park
Glaisher Drive, Wolverhampton
West Midlands WV10 9RU, UK
Phone: +44 121 4000 231
Fax: +44 121 270 9694
www.tungaloy.co.jp/uk
salesinfo@tungaloyuk.co.uk

Tungaloy Hungary Kft

Erzsébet királyné útja 125
H-1142 Budapest, Hungary
Phone: +36 1 781-6846
Fax: +36 1 781-6866
www.tungaloy.co.jp/hu
info@tungaloytools.hu

Tungaloy Turkey

Dudullu, OSB 4. Cad No:4
34776 Umraniye Istanbul, TURKEY
Phone: +90 216 540 04 67
Fax: +90 216 540 04 87
www.tungaloy.com.tr
info@tungaloy.com.tr

Tungaloy Benelux b.v.

Tjalk 70
NL-2411 NZ Bodegraven, Netherlands
Phone: +31 172 630 420
Fax: +31 172 630 429
www.tungaloy-benelux.com

Tungaloy Croatia

Josipa Kozarca 4
10432 Bregana, Croatia
Phone: +385 1 3326 604
Fax: +385 1 3327 683
www.tungaloy.hr

Tungaloy Cutting Tool (Shanghai) Co., Ltd.

Rm No 401 No.88 Zhabei
Jiangchang No.3 Rd
Shanghai 200436, China
Phone: +86-21-3632-1880
Fax: +86-21-3621-1918
www.tungaloy.co.jp/tcts

Tungaloy Cutting Tool (Thailand) Co., Ltd.

Interlink tower 4th Fl.
1858/5-7 Bangna-Trad Road
km.5 Bangna, Bangna, Bangkok 10260
Thailand
Phone: +66-2-751-5711
Fax: +66-2-751-5715
www.tungaloy.co.th

Tungaloy Singapore (Pte.), Ltd.

62 Ubi Road 1, #06-11 Oxley BizHub 2
Singapore 408734
Phone: +65-6391-1833
Fax: +65-6299-4557
www.tungaloy.co.jp/tspl

Tungaloy Vietnam

LE 04-38, Lexington Residence
67 Mai Chi Tho, Dist. 2,
Ho Chi Minh City, Vietnam
Phone: +84-8-37406660
Fax: +84-8-37406662
www.tungaloy.co.jp/tspl

Tungaloy India Pvt. Ltd.

Indiabulls Finance Centre,
Unit # 902-A, 9th Floor,
Tower 1, Senapati Bapat Marg,
Elphinstone Road (West),
Mumbai -400013, India
Phone: +91-22-6124-8804
Fax: +91-22-6124-8899
www.tungaloy.co.jp/in

Tungaloy Korea Co., Ltd

#1312, Byucksan Digital Valley 5-cha
Beotkkot-ro 244, Geumcheon-gu
153-788 Seoul, Korea
Phone: +82-2-2621-6161
Fax: +82-2-6393-8952
www.tungaloy.co.jp/kr

Tungaloy Malaysia Sdn Bhd

50 K-2, Kelana Mall, Jalan SS6/14
Kelana Jaya, 47301
Petaling Jaya, Selangor Darul Ehsan
Malaysia
Phone: +603-7805-3222
Fax: +603-7804-8563
www.tungaloy.co.jp/my

Tungaloy Australia Pty Ltd

PO Box 2232, Rowville,
Victoria 3178, Australia
Phone: +61-3-9755-8147
Fax: +61-3-9755-6070
www.tungaloy.com.au

PT. Tungaloy Indonesia

Kompleks Grand Wisata Block AA-10 No.3-5
Cibitung
Bekasi 17510, Indonesia
Phone: +62-21-8261-5808
Fax: +62-21-8261-5809
www.tungaloy.co.jp/id



www.tungaloy.com

follow us at:
facebook.com/tungaloyjapan
twitter.com/tungaloyjapan

To see this product in action visit:

Tung-TV

www.youtube.com/tungaloycorporation

Distributed by:



DOWNLOAD
Dr. Carbide App



Available on the
App Store



GET IT ON
Google play

