

GrooveLine



TUNGCUT

www.tungaloy.com

Tungaloy Report No. 391-G

High pressure **through-coolant blade** and **new holders** for OD grooving / parting applications **DTE inserts / T9225** CVD grade



INDUSTRY 4.0
FEED the SPEED!



32 CHP

29031

max Ø100mm
(Ø3.94")

50 40 30

ACCELERATED MACHINING

GrooveLine

TUNGCUT
TUNGALOY



Multi-functional tool series offering a wide range of grades, geometries, and holder variations for **maximum performance with minimum tool investments**

High-pressure coolant system improves chip flow and tool life

New modular holder system enhances versatility of existing monoblock holder and TungCap (PSC) lines.

New



Multi-functional grooving system

Suitable for diverse grooving operations

External grooving, turning, and parting

CTER/L-CHP (P.36) **CTER/L (P.34)**

- Screw clamp
- CW (for external coolant) = 2 mm - 8 mm
- CW (for high pressure coolant) = 2 mm - 8 mm
- CDX = 8 mm - 36 mm
- Shank size: 16mm - 32 mm

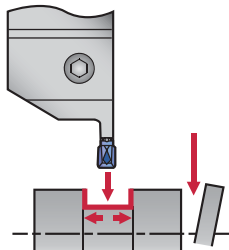

JCTER/L-CHP (P.48) **JCTER/L (P.47)**

- Screw clamp
- CW = 1.4 mm - 3 mm
- CW (for high pressure coolant) = 2 mm
- CDX = 10 mm - 16 mm
- Shank size: 10mm - 20 mm
- Small swiss-type CNC machines

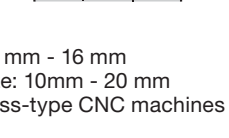

CAER/L-CHP (P.39) **CAER/L (P.54)**

- Blade type
- Screw clamp
- CW (for external coolant) = 3 mm - 6 mm
- CW (for high pressure coolant) = 3 mm - 6 mm
- CDX = 16 mm - 20 mm
- Shank size: 20mm - 32 mm
- For 20 x 20 mm and 25 x 25 mm shanks with CHP capability

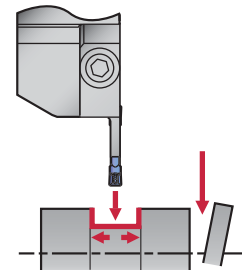

CGER/L (P.48)

- Self clamp
- CW = 1.4 mm - 3 mm
- CDX = 10 mm - 16 mm
- Shank size: 12 mm - 20 mm
- Small swiss-type CNC machines

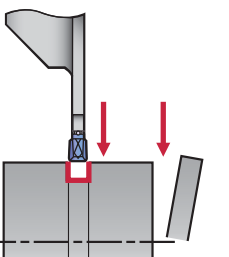

CGP (P.50) **CGP-CHP (P.49)**

- Self clamp
- CW = 1.4 mm - 8 mm
- Max parting dia: $\phi 120$ mm
- Shank size: 20 mm - 25 mm

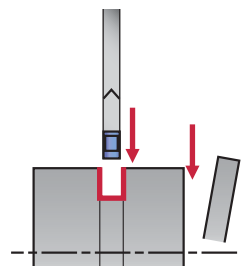

External and internal undercutting

CGEUR/L (P.38)

- Screw clamp
- CW = 3 mm - 6 mm
- CDX = 2.8 mm - 3.4 mm
- Shank size: 16 mm - 25 mm

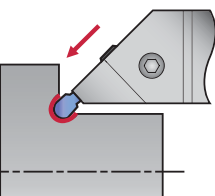

CGIUR/L (P.44)

- Screw clamp
- CW = 3 mm - 6 mm
- CDX = 2.8 mm
- Shank size: $\phi 20$ mm - $\phi 25$ mm

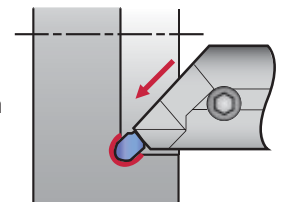

External and face grooving, and turning

CTEFR/L (P.37)

- Screw clamp
- CW = 2 mm - 6 mm
- CDX = 4.8 mm
- Shank size: 20 mm - 25 mm
- Minimum face grooving diameter: DAXMIN = ϕ 19 -

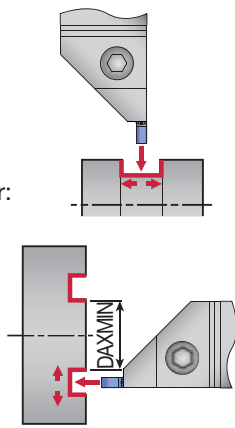

New

CAEFR/L-CHP (P.39)

- Blade type
- Screw clamp
- CW (for high pressure coolant) = 2 mm - 6 mm
- CDX = 4.8 mm
- For 20 x 20 mm and 25 x 25 mm shanks with CHP capability
- Minimum face grooving diameter: DAXMIN = ϕ 19 -

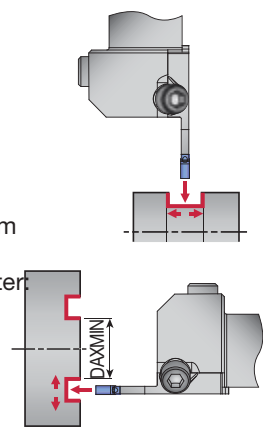

Face grooving and turning

CTFR/L (P.45)

- Screw clamp
- CW = 3 mm - 6 mm
- CDX = 10 mm - 25 mm
- Shank size: 25 mm
- Minimum face grooving diameter: DAXMIN = ϕ 24 -

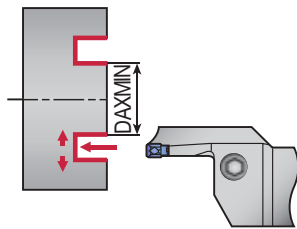

CAFR/L (P.55)

- Blade type
- Screw clamp
- CW = 3 mm - 6 mm
- CDX = 12 mm - 25 mm
- Shank size: 20 mm - 32 mm
- Minimum face grooving diameter: DAXMIN = ϕ 40 -

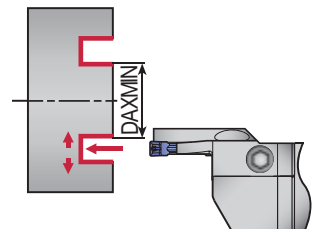

CTFVR/L (P.46)

- Screw clamp
- CW = 3 mm - 6 mm
- CDX = 10 mm - 20 mm
- Shank size: 25 mm
- Minimum face grooving diameter: DAXMIN = ϕ 24 -

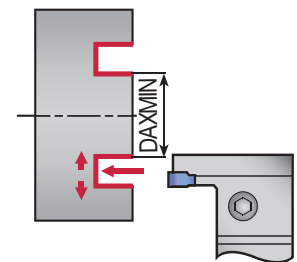

Face grooving, internal face grooving and turning

CTIFR/L (P.43)

- Screw clamp
- CW = 3 mm - 6 mm
- CDX = 5.5 mm
- Shank size: ϕ 25 mm - ϕ 32 mm
- Minimum face grooving diameter: DAXMIN = ϕ 19 -
- Minimum bore diameter: DMIN = ϕ 26.3 -

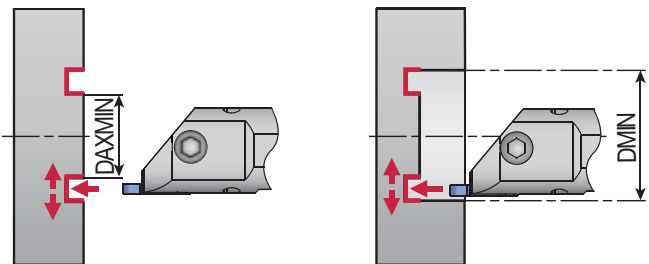

Internal grooving and turning

CTIR/L (P.42)

- Screw clamp
- W = 2 mm - 8 mm
- ar = 4 mm - 10 mm
- Shank size: ϕ 16 mm - ϕ 40 mm
- Minimum bore diameter: DMIN = ϕ 25 -

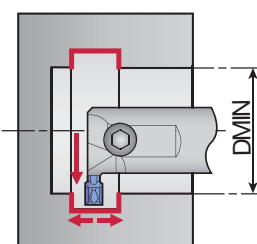

High clamping rigidity

For stable tool life and accuracy

Clamping system



Stable and safe contact areas



High repeatability and durability due to long pocket!

Minimizes cutting edge displacement

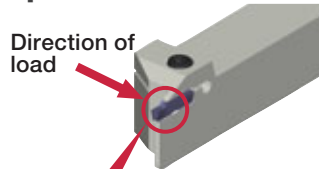
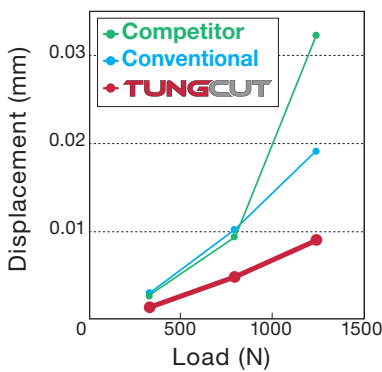

Benefits of TungTurn-Jet high pressure coolant supply

Drastically improved tool life

P Steel : External grooving (S45C / C45 , 245HB)

Material : S45C
 Toolholder : CHSL2525-CHP + CAEL-3T20-CHP
 Insert : DGM3-020 AH7025
 Cutting speed : $V_c = 180$ m/min
 Feed : $f = 0.12$ mm/rev
 Groove width : 3 mm

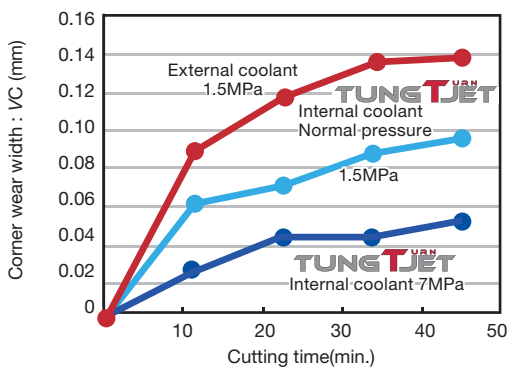

External coolant 1.5MPa 46min



Plastic deformation

Normal pressure 1.5MPa 46min



Corner wear

Internal coolant 7MPa 46min





Excellent chip control

P Steel : External Grooving
(S45C / C45 , 245HB)

DGS





Material : S45C
Holder : CHSL2525-CHP + CAEL-3T20-CHP
Insert : DGS3-020 AH7025
DTX3-030 AH7025
Cutting speed : $V_c = 180$ m/min
Feed rate : $f = 0.05$ mm/rev
Groove width : 3 mm

TUNG T ^{URN} JET 7 MPa	Normal pressure coolant 1.5MPa
	

DTX

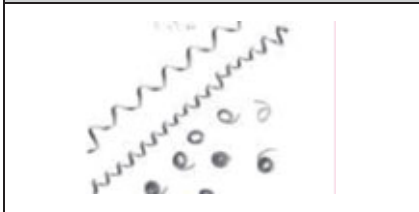

TUNG T ^{URN} JET 7 MPa	Normal pressure coolant 1.5MPa
	



Excellent chip control

S Inconel 718

DGS





Material : Inconel718
Holder : C6CHSN33050-CHP + CAEL-3T20-CHP
Insert : DGS3-020 AH7025
DGG300-020 KS05F
Cutting speed : $V_c = 40$ m/min
Feed rate : $f = 0.05$ mm/rev
Groove width : 3 mm

TUNG T ^{URN} JET 7 MPa	Normal pressure coolant 1.5MPa
	

DGG

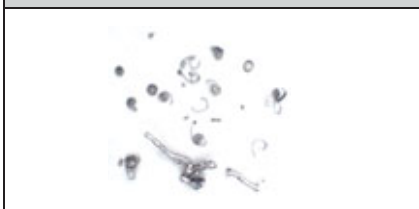

TUNG T ^{URN} JET 7 MPa	Normal pressure coolant 1.5MPa
	



GROOVING, PARTING, AND TURNING

DTE

Its wide cutting edge is designed to provide good chip control at high feed rates



DTM

First choice chipbreaker for various applications. Optimized geometry for smooth chip breaking and flow



DTX

Provides good cutting performance in grooving. Its narrow cutting edge width provides excellent chip formation at low feed rates



P Carbon steel
(S45C / C45)

M Stainless steel
(SUS304 / X5CrNi18-9)

DTE4-040

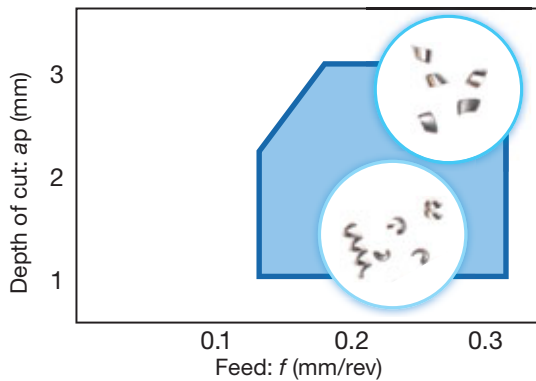

DTE4-040

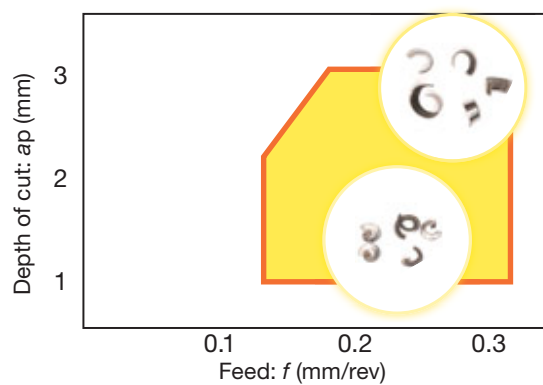

DTM4-040

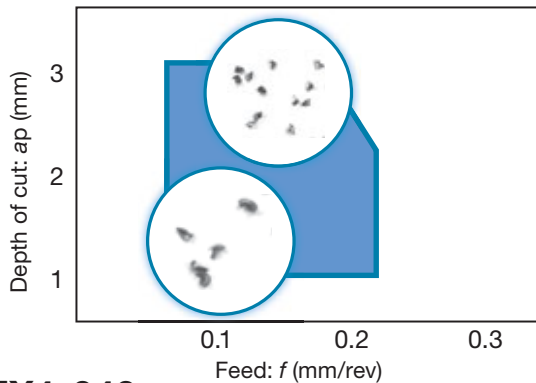

DTM4-040

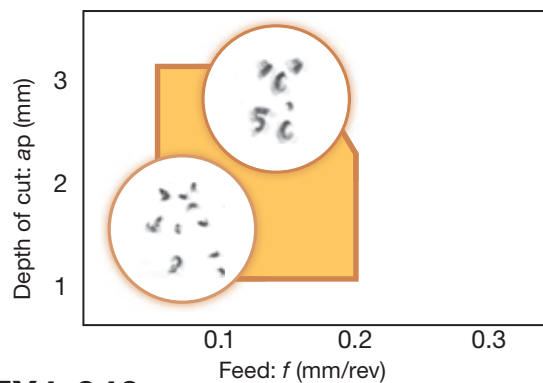

DTX4-040

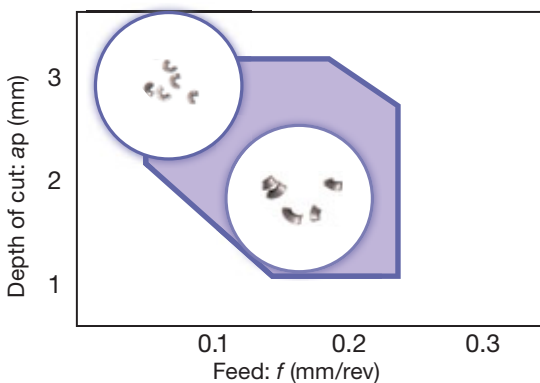

DTX4-040

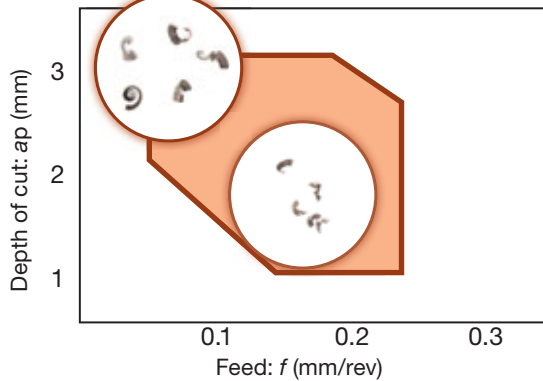

A wide range of chipbreakers provide excellent chip formation in various conditions



GROOVING AND PARTING

Carbon steel
(S45C / C45)



DGM4-030

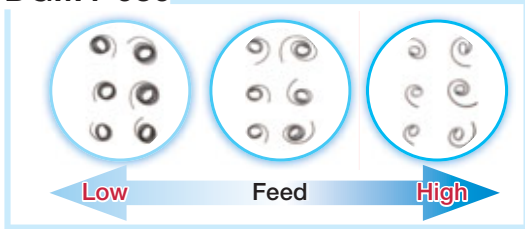

DGS4-030

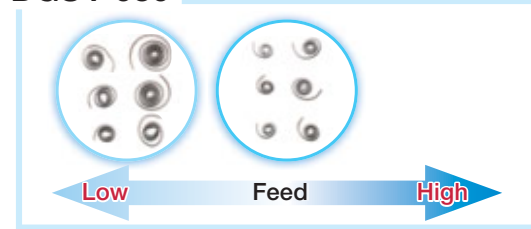

DTE4-040

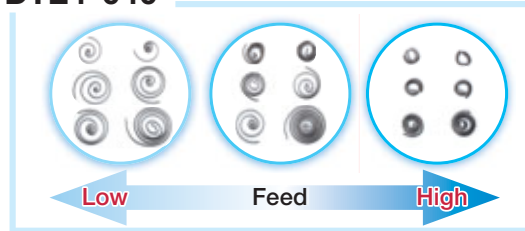

DTX4-040

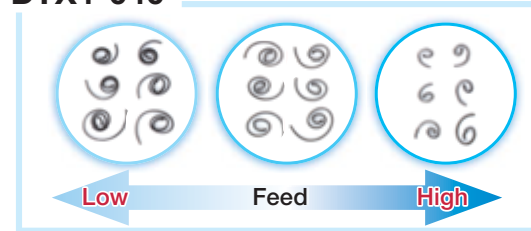

DTE400-040

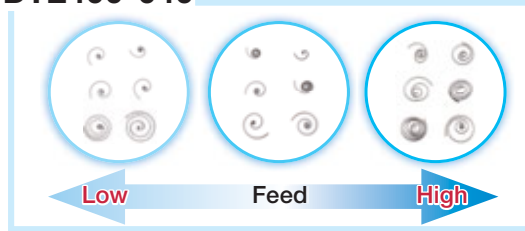

DTM4-040

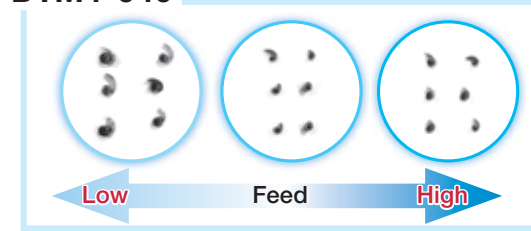

GROOVING AND PARTING

Stainless steel
(SUS304 / X5CrNi18-9)



DGM4-030

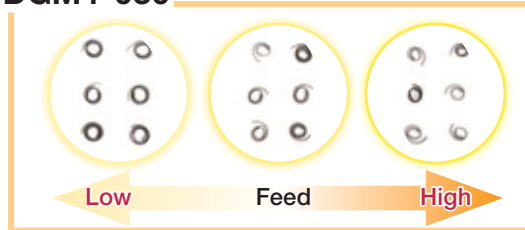

DGS4-030

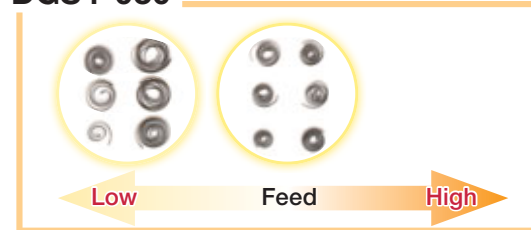

DTE4-040

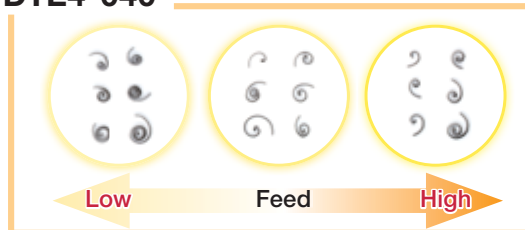

DTX

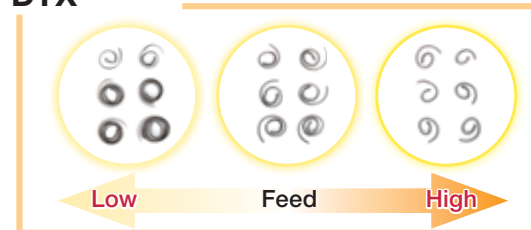

DTE400-040

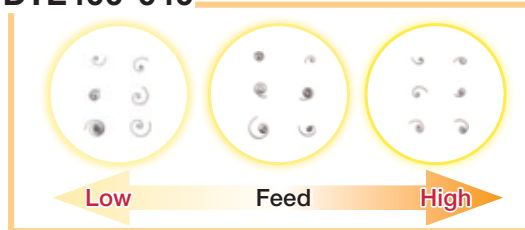

DTM4-040

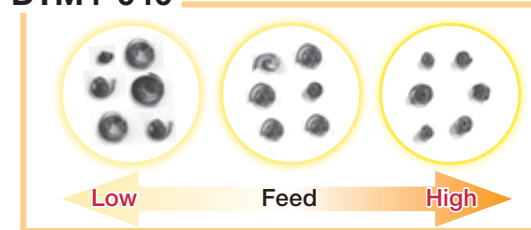

Excellent chip control at low feed rates

P Bearing steel
(B1/52100/SUJ2)

First choice chipbreaker for bearing steel. Excellent chip control at low feed rates.



Material : SUJ2
Holder : CTER2525-3T09
Insert : DGL3-025
Cutting speed : $V_c = 50, 100$ m/min
Groove width : 3 mm

DGL

	$f = 0.03$	$f = 0.05$	$f = 0.07$	$f = 0.1$
$V_c = 50$				
$V_c = 100$				

The latest standard grades

AH7025

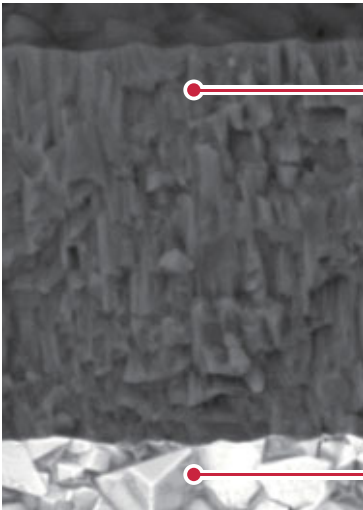

AH7025 uses the world's first coating technology of a nano-scale multi-layered AlTiN PVD coating with high Al content, featuring

- Coating hardness increased by 20%
- A multi-layered coating structure impedes micro-crack propagation, reducing insert failures
- Enhanced adhesion strength between the coating and carbide substrate layer

High wear and fracture resistant carbide substrate for optimal grooving performance

T9200 SERIES **New**

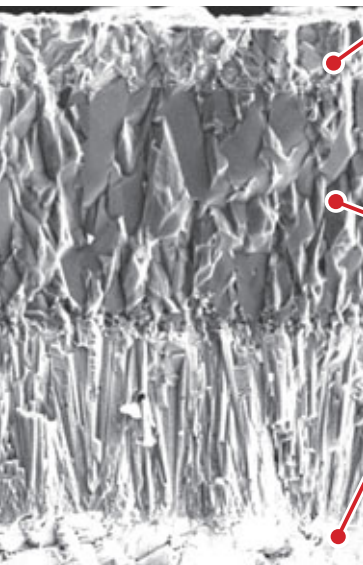

Hard outer layer.

A new developed hard coating layer, with a high resistance to flank wear.

Thick Al₂O₃ layer with excellent resistance to high heat and crater wear, especially effective for high-speed machining.

New cemented carbide substrate.

Exclusively designed for T9200 series drastically reduces defects in alloys, which greatly improves fracture resistance.

CUTTING PERFORMANCE

First choice grade for grooving

AH7025 grade - Tungaloy's unique coating technology for drastically improved reliability

Tool life comparison



Tool wear after 60 grooves

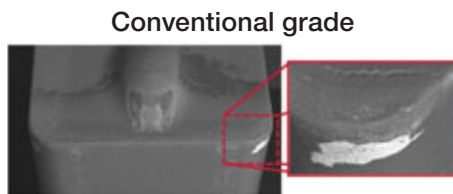

Tool wear after 30 grooves

AH7025 provides stability, while preventing coating from peeling off even after machining twice the number of passes compared to the conventional grade.

P Alloy steel
(SCM440 / 42CrMo4)

Insert : DTE3-040 AH7025
Cutting speed : $V_c = 150$ m/min
Feed : $f = 0.17$ mm/rev
Groove depth : 17 mm
Machining : External grooving
Coolant : Wet

GRADES

AH7025

P M K S

- First choice for various applications
- New PVD coating with high Al content provides excellent adhesion strength
- Improved wear and chipping resistance

AH725

P M S

- Recommended for various applications
- Newly developed coating with well controlled crystal structure and fracture resistance
- Improved adhesion strength

T515

K

- First recommended grade for cast iron
- Excellent wear resistance in high-speed machining

New

T9225

P

- Suitable for steel machining at high speeds
- New CVD coating and substrate deliver an outstanding balance of wear and chipping resistance

T9125

P

- Suitable for steel machining at high speeds
- Balance of wear and chipping resistance

NS9530

P

- Advanced cermet for finish cutting of steel
- Innovative grade with incredible fracture and high wear resistance

GH130

P M K

- Recommended for interrupted machining
- TiCNO PVD coating layer with high wear resistance
- High hardness wear resistance

AH905

S

- Remarkable for machining of heat resistant alloys
- Exclusive coating layer improves adhesion strength and wear resistance

KS05F

N S

- Recommended for non-ferrous materials and titanium

TH10

N

- Recommended for non-ferrous materials

BX360

H

- Suitable for hardened steel machining
- Ideal balance of wear and chipping resistance due to the optimum CBN content and grain size

GRADES

Grade	Substrate		Coating layer		Features
	Specific gravity	Hardness	Main Composition	Thickness (μm)	
AH7025	14.4	91.3 HRA	(Al,Ti)N	3.5	First recommended grade with excellent wear resistance and toughness, that is suitable for machining of a wide range of materials.
AH725	14.4	91.5 HRA	(Ti,Al)N	2	PVD coated on fine grain cemented carbide
T515	14.8	91.5 HRA	TiCN + Al ₂ O ₃	16	Good wear resistance even in high-speed machining First choice for roughing cast iron
T9225	13.8	89.8 HRA	Ti compound + Al ₂ O ₃	18	Exhibits excellent wear and fracture resistant at high cutting speeds
T9125	13.7	90.0 HRA	TiCN + Al ₂ O ₃	16	Versatile grade for improved chipping resistance
NS9530	6.8	91.7 HRA	-	-	Versatile cermet grade with incredible fracture and wear resistance
GH130	14.1	89.5 HRA	TiCNO	3	Superior resistance to chipping and fracture Excels in interrupted cutting
AH905	15.0	93.0 HRA	(Al,Ti)N	1.5	Excels in both cutting edge sharpness and wear resistance
TH10	14.7	92.0 HRA	-	-	Carbide grade with excellent wear resistance and toughness
KS05F	15.0	93.0 HRA	-	-	Carbide grade with excellent wear, fracture, and chip-welding resistances
BX360	-	3200 - 3400 Hv	-	-	CBN grade with exceptional balance of wear and chipping resistance

COMPENSATION OF TOOL LENGTH

The insert may be deflected by axial cutting force during turning, causing the workpiece diameter to be smaller than the required dimension. A minor tool length compensation may, therefore,

be required. Exact amount of change can be measured by running a test workpiece. Refer to the chart below for values for diameter compensation.

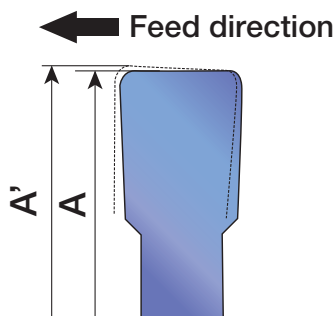

Fig. 1

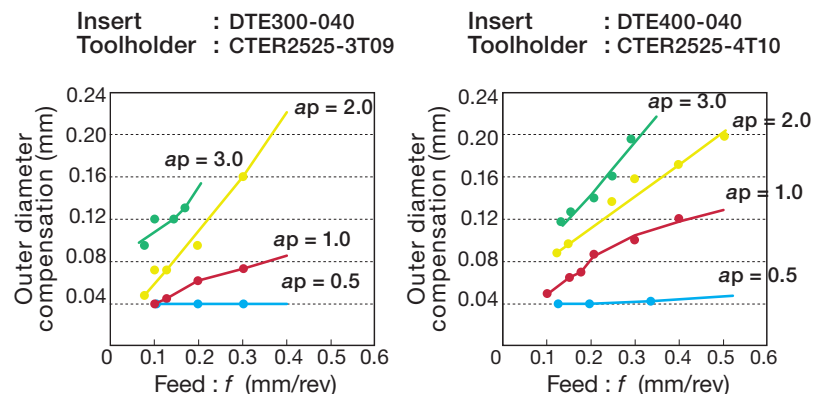
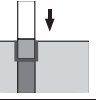
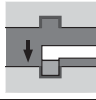

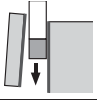
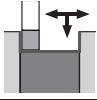
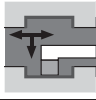



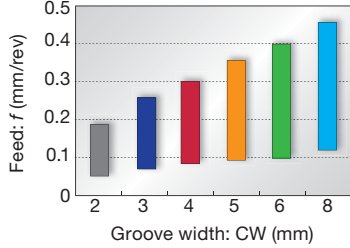
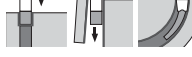

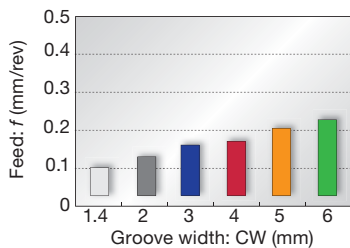
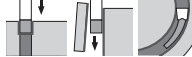

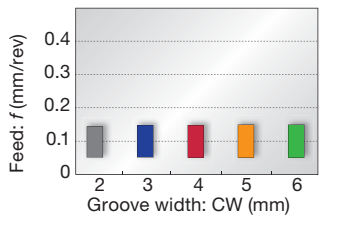
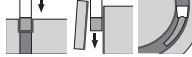

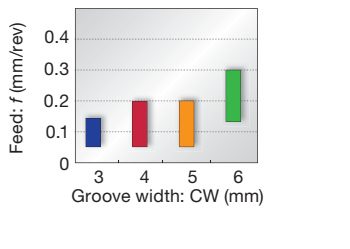
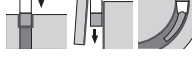
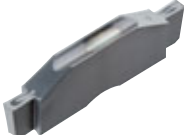
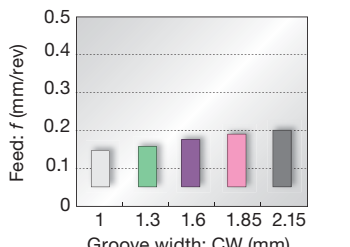

Fig. 2 Value of compensation

INSERT APPLICATION

Insert	Application						
	Grooving			Parting	Turning		
	External	Internal	Face		External	Internal	Face
							
DGM / SGM	●		●	●			
DGS / SGS	●		●	●			
DGG	●		●	●			
DGL	●		●	●			
DGE	●						
DTM	●		●	●	●		●
DTE	●		●		●		●
DTX	●	●	●	●	●	●	●
DTR	●		●		●		●
DTIU	● Undercutting	● Undercutting					
DTI		●				●	
DGIM / DGIS		●					
DTF			●				●
DTA					● Al wheel machining	● Al wheel machining	
SGN	●						

CHIPBREAKER GUIDE

External grooving and parting

<p>DGM type (2 corners) SGM type (1 corner)</p>  <p>P.20, 21</p>	<p>1st choice for grooving and parting</p> <p>Smooth chip evacuation Well-designed edge with high strength Handed insert available CW = 2 - 8 mm</p>	<p>■ Standard feed</p>  <table border="1"> <caption>Standard feed for DGM/SGM</caption> <thead> <tr> <th>Groove width: CW (mm)</th> <th>Feed: f (mm/rev)</th> </tr> </thead> <tbody> <tr><td>2</td><td>0.18</td></tr> <tr><td>3</td><td>0.25</td></tr> <tr><td>4</td><td>0.29</td></tr> <tr><td>5</td><td>0.34</td></tr> <tr><td>6</td><td>0.39</td></tr> <tr><td>8</td><td>0.45</td></tr> </tbody> </table>	Groove width: CW (mm)	Feed: f (mm/rev)	2	0.18	3	0.25	4	0.29	5	0.34	6	0.39	8	0.45	
Groove width: CW (mm)	Feed: f (mm/rev)																
2	0.18																
3	0.25																
4	0.29																
5	0.34																
6	0.39																
8	0.45																
<p>DGS type (2 corners) SGS type (1 corner)</p>  <p>P.22, 23</p>	<p>Lower cutting force and superior sharpness</p> <p>Unique-designed edge and chipbreaker Handed insert available CW = 1.4 - 6 mm</p>	<p>■ Standard feed</p>  <table border="1"> <caption>Standard feed for DGS/SGS</caption> <thead> <tr> <th>Groove width: CW (mm)</th> <th>Feed: f (mm/rev)</th> </tr> </thead> <tbody> <tr><td>1.4</td><td>0.08</td></tr> <tr><td>2</td><td>0.12</td></tr> <tr><td>3</td><td>0.15</td></tr> <tr><td>4</td><td>0.17</td></tr> <tr><td>5</td><td>0.20</td></tr> <tr><td>6</td><td>0.22</td></tr> </tbody> </table>	Groove width: CW (mm)	Feed: f (mm/rev)	1.4	0.08	2	0.12	3	0.15	4	0.17	5	0.20	6	0.22	
Groove width: CW (mm)	Feed: f (mm/rev)																
1.4	0.08																
2	0.12																
3	0.15																
4	0.17																
5	0.20																
6	0.22																
<p>DGG type (2 corners)</p>  <p>P.24</p>	<p>For non-ferrous materials and titanium</p> <p>Chipbreaker with low cutting force Sharp cutting edge that prevents vibration and delivers fine surface finish CW = 2 - 6 mm</p>	<p>■ Standard feed</p>  <table border="1"> <caption>Standard feed for DGG</caption> <thead> <tr> <th>Groove width: CW (mm)</th> <th>Feed: f (mm/rev)</th> </tr> </thead> <tbody> <tr><td>2</td><td>0.12</td></tr> <tr><td>3</td><td>0.14</td></tr> <tr><td>4</td><td>0.15</td></tr> <tr><td>5</td><td>0.16</td></tr> <tr><td>6</td><td>0.17</td></tr> </tbody> </table>	Groove width: CW (mm)	Feed: f (mm/rev)	2	0.12	3	0.14	4	0.15	5	0.16	6	0.17			
Groove width: CW (mm)	Feed: f (mm/rev)																
2	0.12																
3	0.14																
4	0.15																
5	0.16																
6	0.17																
<p>DGL type (2 corners)</p>  <p>P.24</p>	<p>1st choice for mild steel</p> <p>Chipbreaker with excellent chip control at low feed Suitable for mild steel that often gives difficulties in chip control CW = 3 - 6 mm</p>	<p>■ Standard feed</p>  <table border="1"> <caption>Standard feed for DGL</caption> <thead> <tr> <th>Groove width: CW (mm)</th> <th>Feed: f (mm/rev)</th> </tr> </thead> <tbody> <tr><td>3</td><td>0.15</td></tr> <tr><td>4</td><td>0.20</td></tr> <tr><td>5</td><td>0.20</td></tr> <tr><td>6</td><td>0.30</td></tr> </tbody> </table>	Groove width: CW (mm)	Feed: f (mm/rev)	3	0.15	4	0.20	5	0.20	6	0.30					
Groove width: CW (mm)	Feed: f (mm/rev)																
3	0.15																
4	0.20																
5	0.20																
6	0.30																
<p>DGE type (2 corners)</p>  <p>P.25</p>	<p>For high accurate and shallow groove</p> <p>Excellent chip control CW = 1 - 2.15 mm</p>	<p>■ Standard feed</p>  <table border="1"> <caption>Standard feed for DGE</caption> <thead> <tr> <th>Groove width: CW (mm)</th> <th>Feed: f (mm/rev)</th> </tr> </thead> <tbody> <tr><td>1</td><td>0.14</td></tr> <tr><td>1.3</td><td>0.15</td></tr> <tr><td>1.6</td><td>0.17</td></tr> <tr><td>1.85</td><td>0.18</td></tr> <tr><td>2.15</td><td>0.19</td></tr> </tbody> </table>	Groove width: CW (mm)	Feed: f (mm/rev)	1	0.14	1.3	0.15	1.6	0.17	1.85	0.18	2.15	0.19			
Groove width: CW (mm)	Feed: f (mm/rev)																
1	0.14																
1.3	0.15																
1.6	0.17																
1.85	0.18																
2.15	0.19																

External and face grooving, and turning

DTM type
(2 corners)



P.26

General purpose

1st choice for grooving and turning
Suitable for light to medium cutting
Excellent chip control in machining
steel, alloy steel, stainless steel,
and heat-resistant alloy
CW = 3 - 8 mm

Standard feed and DoC

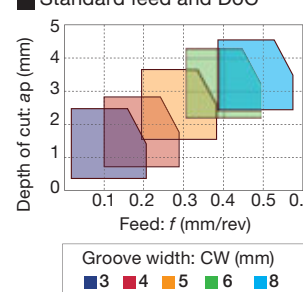

Standard feed

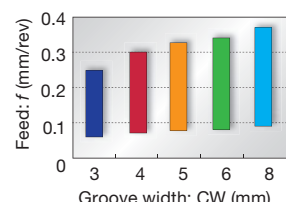

DTE type
(2 corners)



P.27, 28

General purpose

Unique chipbreaker makes
chips shorter
Molded and ground insert
available
CW = 3 - 8 mm

Standard feed and DoC

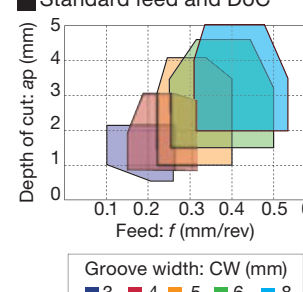

Standard feed

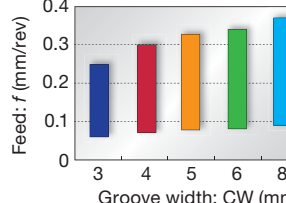

External, internal and face grooving, and turning

DTX type
(2 corners)



P.28

Multi-functional type

Well balanced sharpness
and strength
Multi-functional insert
CW = 3 - 6 mm



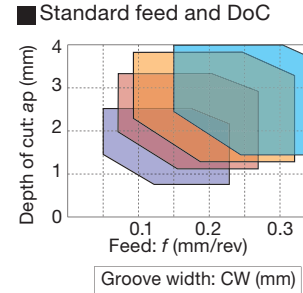

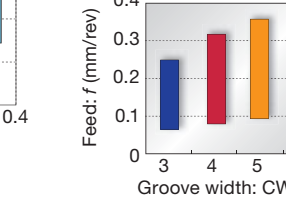

Standard feed and DoC



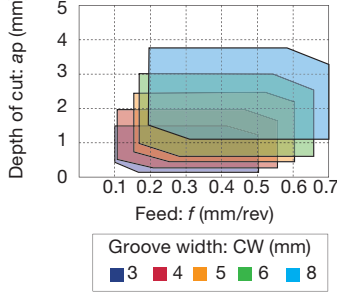
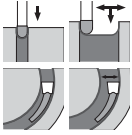

Standard feed

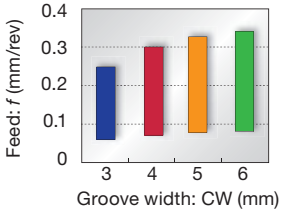

Profiling and undercutting

<p>DTR type (2 corners)</p> <p>Molded</p>  <p>Ground</p>  <p>P.29</p>	<p>Full radius type</p> <p>Excellent chip control</p> <p>Molded and ground inserts available</p> <p>CW = 3 - 8 mm</p>	<p>Standard feed and DoC</p>  
<p>DTIU type (2 corners)</p>  <p>P.30</p>	<p>Full radius type</p> <p>Excellent chip control for undercutting</p> <p>CW = 3 - 6 mm</p>	<p>Standard feed and DoC</p>  

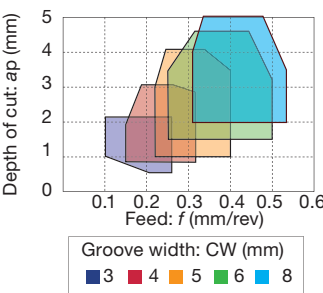
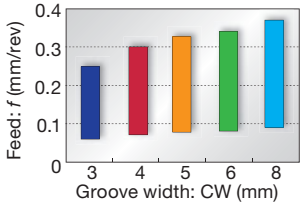
Internal grooving and turning

<p>DTI type (2 corners)</p>  <p>P.30, 31</p>	<p>Internal</p> <p>Unique chipbreaker makes chips shorter</p> <p>Molded and ground inserts available</p> <p>CW = 3 - 8 mm</p>	<p>Standard feed and DoC</p>  <p>Standard feed</p>  
--	--	--

Small diameter internal grooving

DGIM type (2 corners)



2 mm insert width only (For general purpose)
 Unique chipbreaker for excellent chip control
 Excellent fracture resistance due to optimum land on the cutting edge For general applications on steels & stainless steels
 CW = 2 mm

P.31

Standard feed

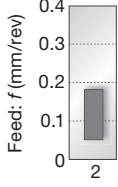

Feed: f (mm/rev)

Groove width: CW (mm)



DGIS type (2 corners)



2 mm insert width only (Lower cutting force)
 Lower cutting force
 Excellent fracture resistance due to optimum land on the cutting edge
 Applicable for low carbon steels & stainless steels
 CW = 2 mm

P.32

Standard feed

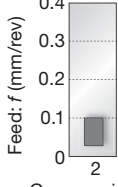

Feed: f (mm/rev)

Groove width: CW (mm)



Face grooving and turning

DTF type (2 corners)



1st choice for face grooving
 Unique chipbreaker makes chips shorter
 Molded and ground insert available
 CW = 3 - 4 mm

P.32

Standard feed and DoC

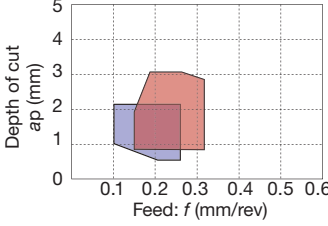

Depth of cut a_p (mm)

Feed: f (mm/rev)

Groove width: CW (mm)

■ 3 ■ 4

Standard feed

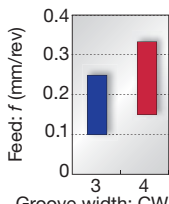

Feed: f (mm/rev)

Groove width: CW (mm)



Aluminium wheel machining

DTA type (2 corners)



P.33

Full radius type

Excellent chip control
For aluminium wheel profiling
Ground insert
CW = 6 - 8 mm

Standard feed and DoC

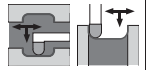
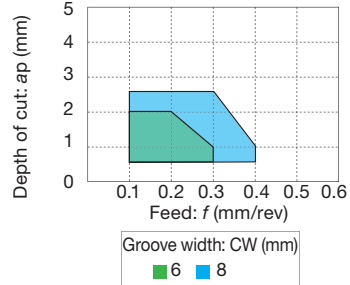

External grooving of hardened steel

SGN-CBN type (1 corner)

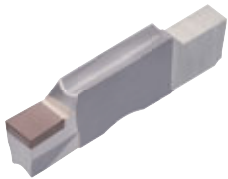

P.33

For hardened steel cutting

Optimum cutting edge shape for grooving of hardened steels
High tolerance width for finishing
CW = 2 - 4 mm
(CW = ± 0.025 mm)

Standard feed

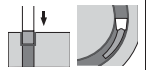
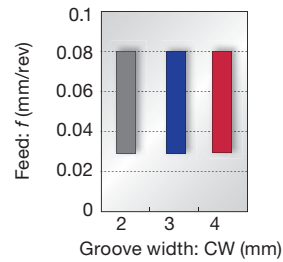

INSERT

DGM

External grooving and parting, 2 corners

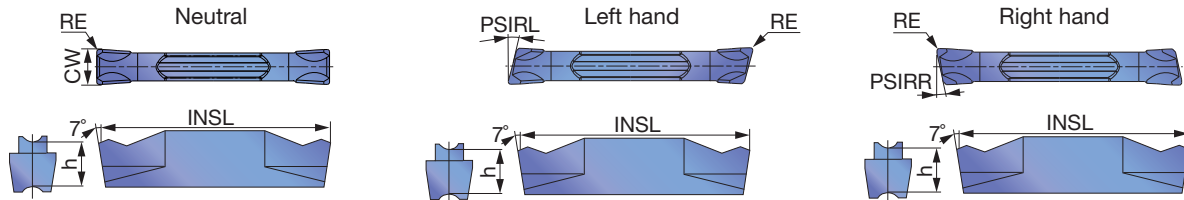

P Steel	★	★	★	☆	☆		★					
M Stainless	★		★	☆	★							
K Cast iron	☆		★	☆	☆		☆					
N Non-ferrous												
S Superalloys			★	☆	★							
H Hard materials												

★ : First choice
☆ : Second choice

Designation	Seat size	HAND	CW±0.05	RE	Coated					Cermet	INSL	h	PSIRL	PSIRR	
					New T9225	T9125	AH7025	AH725	AH905	GH130					NS9530
DGM2-020	2	N	2	0.2	●	▲	●	●	●	●	●	20	5	0°	0°
DGM2-020-6R	2	R	2	0.2			●	●	●			19.8	5	0°	6°
DGM2-020-6L	2	L	2	0.2			●	●	●			19.8	5	6°	0°
DGM2-020-8R	2	R	2	0.2			●	●	●			19.8	5	0°	8°
DGM2-020-8L	2	L	2	0.2			●	●	●			19.8	5	8°	0°
DGM2-020-15R	2	R	2	0.2			●	●	●			19.8	5	0°	15°
DGM2-020-15L	2	L	2	0.2			●	●	●			19.8	5	15°	0°
DGM2-002-15R	2	R	2	0.02				●	●			19.35	5	0°	15°
DGM2-002-15L	2	L	2	0.02				●	●			19.35	5	15°	0°
DGM3-020	3	N	3	0.2	●	▲	●	●	●	●	●	20	5	0°	0°
DGM3-020-6R	3	R	3	0.2			●	●	●			19.9	5	0°	6°
DGM3-020-6L	3	L	3	0.2			●	●	●			19.9	5	6°	0°
DGM3-002-6R	3	R	3	0.02				●	●			19.45	5	0°	6°
DGM3-002-6L	3	L	3	0.02				●	●			19.45	5	6°	0°
DGM3-020-15R	3	R	3	0.2			●	●	●			19.9	5	0°	15°
DGM3-020-15L	3	L	3	0.2			●	●	●			19.9	5	15°	0°
DGM4-030	4	N	4	0.3	●	▲	●	●	●	●	●	20	5	0°	0°
DGM4-030-4R	4	R	4	0.3			●	●	●			19.8	5	0°	4°
DGM4-030-4L	4	L	4	0.3			●	●	●			19.8	5	4°	0°
DGM4-030-15R	4	R	4	0.3			●	●	●			19.8	5	0°	15°
DGM4-030-15L	4	L	4	0.3			●	●	●			19.8	5	15°	0°
DGM5-030	5	N	5	0.3	●	▲	●	●	●	●	●	25	5.5	0°	0°
DGM5-030-4R	5	R	5	0.3			●	●	●			24.9	5.5	0°	4°
DGM6-030	6	N	6	0.3	●	▲	●	●	●	●	●	25	5.5	0°	0°
DGM8-040	8	N	8	0.4	●	▲	●	●	●	●	●	30	6.7	0°	0°

● : New
● : Line up
▲ : To be discontinued

SGM

External deep grooving and parting, 1 corner

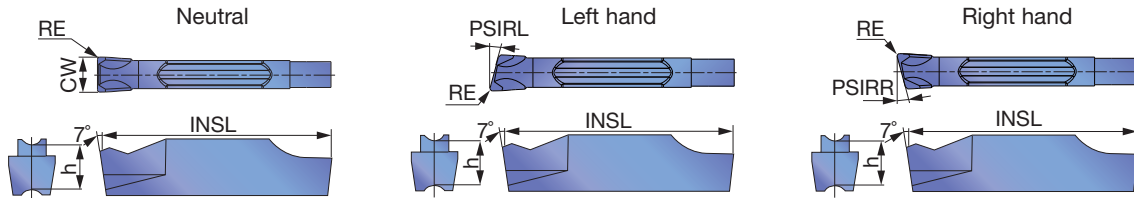

P	Steel	★	☆	☆						
M	Stainless	★	☆	★						
K	Cast iron	★	☆							
N	Non-ferrous									
S	Superalloys	★	☆							
H	Hard materials									

★ : First choice
☆ : Second choice

Designation	Seat size	HAND	CW±0.05	RE	Coated										INSL	h	PSIRL	PSIRR	
					AH7025	AH725	GH130												
SGM2-020	2	N	2	0.2	●	●	●									20	5	0°	0°
SGM2-020-6R	2	R	2	0.2	●	●	●									20	5	0°	6°
SGM2-020-6L	2	L	2	0.2	●	●	●									20	5	6°	0°
SGM3-020	3	N	3	0.2	●	●	●									20	5	0°	0°
SGM3-020-6R	3	R	3	0.2	●	●	●									20	5	0°	6°
SGM3-020-6L	3	L	3	0.2	●	●	●									20	5	6°	0°
SGM3-020-15R	3	R	3	0.2	●	●	●									20	5	0°	15°
SGM3-020-15L	3	L	3	0.2	●	●	●									20	5	15°	0°
SGM4-030	4	N	4	0.3	●	●	●									20	5	0°	0°
SGM4-030-4R	4	R	4	0.3	●	●	●									20	5	0°	4°
SGM4-030-4L	4	L	4	0.3	●	●	●									20	5	4°	0°
SGM5-030	5	N	5	0.3	●	●	●									25	5.5	0°	0°
SGM6-030	6	N	6	0.3	●	●	●									25	5.5	0°	0°

● : Line up

DGS

External grooving and parting, 2 corners

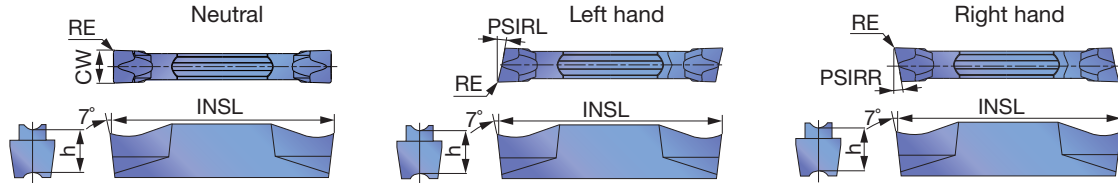

P	Steel	★	★	★	☆	☆		★				
M	Stainless	★		★	☆	★						
K	Cast iron	☆		★		☆		☆				
N	Non-ferrous											
S	Superalloys			★	☆							
H	Hard materials											

★ : First choice
☆ : Second choice

Designation	Seat size	HAND	CW±0.05	RE	Coated					Cermet		INSL	h	PSIRL	PSIRR
					T9225	T9125	AH7025	AH725	GH130	NS9530					
DGS1.4-016	1	N	1.4	0.16			●	●	●			16	4.3	0°	0°
DGS2-020	2	N	2	0.2	●	▲	●	●	●	●		20	5	0°	0°
DGS2-020-6R	2	R	2	0.2			●	●	●			19.95	5	0°	6°
DGS2-020-6L	2	L	2	0.2			●	●	●			19.95	5	6°	0°
DGS2-002-6R	2	R	2	0.02				●	●			19.5	5	0°	6°
DGS2-002-6L	2	L	2	0.02				●	●			19.5	5	6°	0°
DGS2-020-15R	2	R	2	0.2			●	●	●			19.95	5	0°	15°
DGS2-020-15L	2	L	2	0.2			●	●	●			19.95	5	15°	0°
DGS2-002-15R	2	R	2	0.02				●	●			19.5	5	0°	15°
DGS2-002-15L	2	L	2	0.02				●	●			19.5	5	15°	0°
DGS3-020	3	N	3	0.2	●	▲	●	●	●	●		20	5	0°	0°
DGS3-020-6R	3	R	3	0.2			●	●	●			19.9	5	0°	6°
DGS3-020-6L	3	L	3	0.2			●	●	●			19.9	5	6°	0°
DGS3-002-6R	3	R	3	0.02				●	●			19.45	5	0°	6°
DGS3-002-6L	3	L	3	0.02				●	●			19.45	5	6°	0°
DGS3-020-15R	3	R	3	0.2			●	●	●			19.9	5	0°	15°
DGS3-020-15L	3	L	3	0.2			●	●	●			19.9	5	15°	0°
DGS3-002-15R	3	R	3	0.02				●	●			19.45	5	0°	15°
DGS3-002-15L	3	L	3	0.02				●	●			19.45	5	15°	0°
DGS4-030	4	N	4	0.3	●	▲	●	●	●	●		20	5	0°	0°
DGS4-030-4R	4	R	4	0.3			●	●	●			19.8	5	0°	4°
DGS4-030-4L	4	L	4	0.3			●	●	●			19.85	5	4°	0°
DGS5-030	5	N	5	0.3	●	▲	●	●	●	●		25	5.5	0°	0°
DGS6-030	6	N	6	0.3	●	▲	●	●	●			25	5.5	0°	0°

●: New
●: Line up
▲: To be discontinued

Caution

The tool will interfere with the workpiece when grooving larger diameter than ϕD_{max} .

Designation	ϕD_{max} (mm)	Designation	ϕD_{max} (mm)
DGM2-002-15R/L	28	DGS2-002-15R/L	28
DGM3-002-15R/L	29	DGS3-002-15R/L	29
DGM4-030-15R/L	30	SGS3-020-15R/L	103
SGM3-020-15R/L	103	SGS3-002-15R/L	34

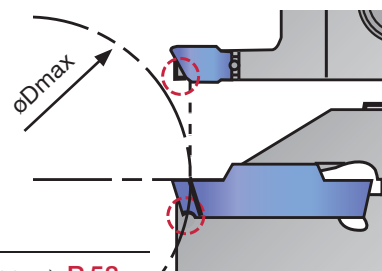

Reference pages: Toolholders → P.34 - 57, Standard cutting conditions → P.58

SGS

External deep grooving and parting, 1 corner

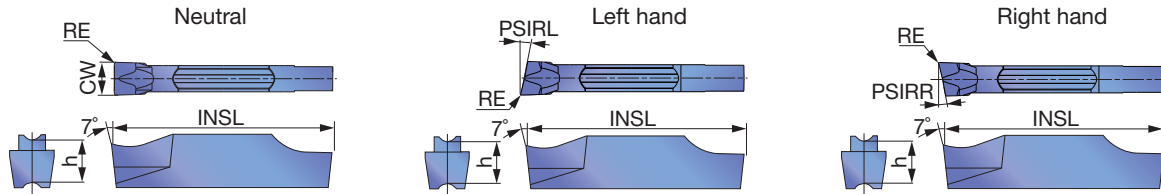

P	Steel	★	☆	☆						
M	Stainless	★	☆	★						
K	Cast iron	★		☆						
N	Non-ferrous									
S	Superalloys	★	☆							
H	Hard materials									

★ : First choice
☆ : Second choice

Designation	Seat size	HAND	CW±0.05	RE	Coated										INSL	h	PSIRL	PSIRR	
					AH7025	AH725	GH130												
SGS2-020	2	N	2	0.2	●	●	●									20	5	0°	0°
SGS2-020-6R	2	R	2	0.2	●	●	●									20	5	0°	6°
SGS2-020-6L	2	L	2	0.2	●	●	●									20	5	6°	0°
SGS2-020-15R	2	R	2	0.2	●	●	●									20	5	0°	15°
SGS2-020-15L	2	L	2	0.2	●	●	●									20	5	15°	0°
SGS3-020	3	N	3	0.2	●	●	●									20	5	0°	0°
SGS3-020-6R	3	R	3	0.2	●	●	●									20	5	0°	6°
SGS3-020-6L	3	L	3	0.2	●	●	●									20	5	6°	0°
SGS3-002-6R	3	R	3	0.02		●	●									19.8	5	0°	6°
SGS3-002-6L	3	L	3	0.02		●	●									19.8	5	6°	0°
SGS3-020-15R	3	R	3	0.2	●	●	●									20	5	0°	15°
SGS3-020-15L	3	L	3	0.2	●	●	●									20	5	15°	0°
SGS3-002-15R	3	R	3	0.02		●	●									19.8	5	0°	15°
SGS3-002-15L	3	L	3	0.02		●	●									19.8	5	15°	0°
SGS4-030	4	N	4	0.3	●	●	●									20	5	0°	0°
SGS5-030	5	N	5	0.3	●	●	●									25	5.5	0°	0°
SGS6-030	6	N	6	0.3	●	●	●									25	5.5	0°	0°

●: Line up

DGG

External grooving (for high precision)

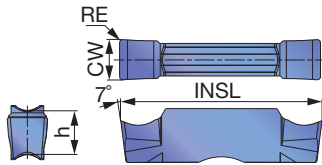

P	Steel	★		★					
M	Stainless	★							
K	Cast iron	★		☆		☆			
N	Non-ferrous					★			
S	Superalloys	★				☆			
H	Hard materials								

★ : First choice
☆ : Second choice

Designation	Seat size	CW±0.02	RE	Coated		Cermet		Uncoated		INSL	h
				AH7025		NS9530		KS05F			
DGG200-020	2	2	0.2	●		●		●		20	5
DGG300-020	3	3	0.2	●		●		●		20	5
DGG400-040	4	4	0.4	●		●		●		20	5
DGG500-040	5	5	0.4	●		●		●		25	5.5
DGG600-040	6	6	0.4	●		●		●		25	5.5

●: Line up

DGL

External grooving and parting

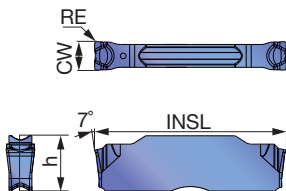

P	Steel	★							
M	Stainless	★							
K	Cast iron	★							
N	Non-ferrous								
S	Superalloys	★							
H	Hard materials								

★ : First choice
☆ : Second choice

Designation	Seat size	CW±0.05	RE	Coated		INSL	h
				AH7025			
DGL3-025	3	3	0.25	●		20	5
DGL4-030	4	4	0.3	●		20	5
DGL5-030	5	5	0.3	●		25	5.5
DGL6-080	6	6	0.8	●		25	5.5

●: Line up

Reference pages: Toolholders → **P.34 - 57**, Standard cutting conditions → **P.58**

DGE

External grooving (for high precision)

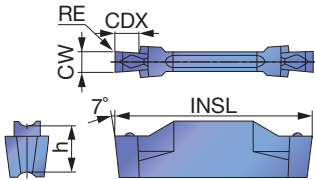

P	Steel	★	☆	☆				★				
M	Stainless	★	☆	★								
K	Cast iron	★		☆				☆				
N	Non-ferrous											
S	Superalloys	★	☆									
H	Hard materials											

★ : First choice
☆ : Second choice

Designation	Seat size	CW±0.05	RE	Coated			Cermet			CDX	INSL	h		
				AH7025	AH725	GH130	NS9530							
DGE100-000	2	1	0		●	●		●				2.5	20	5
DGE130-000	2	1.3	0		●	●		●				2.5	20	5
DGE160-010	2	1.6	0.1	●	●	●		●				2.5	20	5
DGE185-010	2	1.85	0.1	●	●	●		●				3.5	20	5
DGE215-015	2	2.15	0.15	●	●	●		●				3.5	20	5

●: Line up

Caution

øDmax is limited as shown in the picture to the right according to the groove depth, G.D. Please refer to the following table.

G.D = Groove depth

Designation	Max. groove depth (mm)	øDmax (mm)				
		G.D. = 1	G.D. = 1.5	G.D. = 2	G.D. = 2.5	G.D. = 3
DGE100-000	2	∞	18.6	11.5		
DGE130-000					-	-
DGE160-010						
DGE185-010	3				8.8	7
DGE215-015						

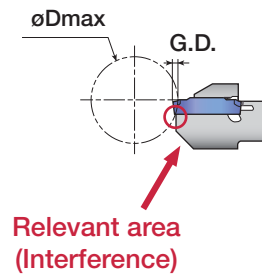

DTM

External face grooving and turning

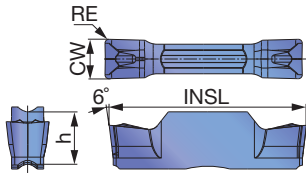

P	Steel	★						
M	Stainless	★						
K	Cast iron	★						
N	Non-ferrous							
S	Superalloys	★						
H	Hard materials							

★ : First choice
☆ : Second choice

Designation	Seat size	CW±0.05	RE	Coated						INSL	h
				AH7025							
DTM3-030	3	3	0.3	●						20	5
DTM4-040	4	4	0.4	●						20	5
DTM4-080	4	4	0.8	●						20	5
DTM5-080	5	5	0.8	●						25	5.5
DTM6-080	6	6	0.8	●						25	5.5
DTM8-080	8	8	0.8	●						30	6.7

● : Line up

DTE

External face grooving and turning (for high precision)

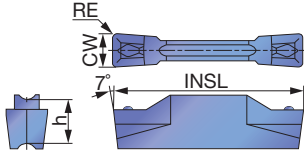

P	Steel	★	★	★	☆	☆			★				
M	Stainless	★		★	☆	★							
K	Cast iron	☆		★		☆							
N	Non-ferrous												
S	Superalloys			★	☆								
H	Hard materials												

★ : First choice
☆ : Second choice

Designation	Seat size	CW±0.02	RE	Coated					Cermet	INSL	h
				New T9225	T9125	AH7025	AH725	GH130	NS9530		
DTE265-015	3	2.65	0.15	●	▲	●	●	●	●	20	5
DTE300-020	3	3	0.2	●	▲	●	●	●	●	20	5
DTE300-040	3	3	0.4	●	▲	●	●	●	●	20	5
DTE315-015	3	3.15	0.15	●	▲	●	●	●	●	20	5
DTE400-040	4	4	0.4	●	▲	●	●	●	●	20	5
DTE400-080	4	4	0.8	●	▲	●	●	●	●	20	5
DTE415-015	4	4.15	0.15	●	▲	●	●	●	●	20	5
DTE478-055	5	4.78	0.55	●	▲	●	●	●	●	25	5.5
DTE500-040	5	5	0.4	●	▲	●	●	●	●	25	5.5
DTE500-080	5	5	0.8	●	▲	●	●	●	●	25	5.5
DTE515-015	5	5.15	0.15	●	▲	●	●	●		25	5.5
DTE600-080	6	6	0.8	●	▲	●	●	●		25	5.5
DTE600-120	6	6	1.2	●	▲	●	●	●		25	5.5
DTE800-080	8	8	0.8	●	▲	●	●	●		30	6.7
DTE800-120	8	8	1.2	●	▲	●	●	●		30	6.7

● : New
● : Line up
▲ : To be discontinued

DTE

External face grooving and turning

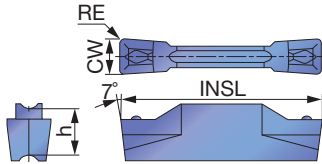

P	Steel	★	★		★	☆	☆		★				
M	Stainless	★			★	☆	★						
K	Cast iron	☆		★	★		☆						
N	Non-ferrous												
S	Superalloys				★	☆							
H	Hard materials												

★ : First choice
☆ : Second choice

Designation	Seat size	CW±0.05	RE	Coated					Cermets			INSL	h	
				T9225	T9125	T515	AH7025	AH725	GH130	NS9530				
New DTE3-020	3	3	0.2				●						20	5
DTE3-040	3	3	0.4	●	▲	●	●	●			●		20	5
DTE4-040	4	4	0.4	●	▲	●	●	●			●		20	5
New DTE4-080	4	4	0.8				●						20	5
DTE5-040	5	5	0.4			●	●						25	5.5
New DTE5-080	5	5	0.8				●						25	5.5
DTE6-080	6	6	0.8			●	●						25	5.5

● : New product
● : Line up
▲ : To be discontinued

DTX

External/Internal face grooving and turning

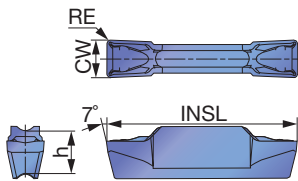

P	Steel	★	★	★	☆	☆			★				
M	Stainless	★			★	☆	★						
K	Cast iron	☆		★		☆			☆				
N	Non-ferrous												
S	Superalloys				★	☆							
H	Hard materials												

★ : First choice
☆ : Second choice

Designation	Seat size	CW±0.05	RE	Coated					Cermets			INSL	h	
				T9225	T9125	AH7025	AH725	GH130	NS9530					
DTX3-030	3	3	0.3	●	▲	●	●	●			●		20	5
DTX4-040	4	4	0.4	●	▲	●	●	●			●		20	5
DTX5-040	5	5	0.4	●	▲	●	●	●			●		25	5.5
DTX6-080	6	6	0.8			●	●	●					25	5.5

● : New
● : Line up
▲ : To be discontinued

Reference pages: Toolholders → P.34 - 57, Standard cutting conditions → P.58

DTR

Profiling and undercutting (for high precision)

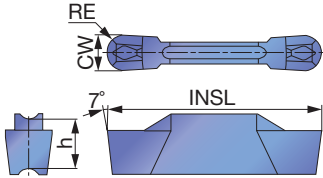

P	Steel	★	★	★	☆	☆		★				
M	Stainless	★		★	☆	★						
K	Cast iron	☆		★		☆		☆				
N	Non-ferrous											
S	Superalloys			★	☆							
H	Hard materials											

★ : First choice
☆ : Second choice

Designation	Seat size	CW±0.02	RE	Coated					Cermets				INSL	h	
				New T9225	T9125	AH7025	AH725	GH130	NS9530						
DTR300-150	3	3	1.5	●	▲	●	●	●		●				20	5
DTR400-200	4	4	2	●	▲	●	●	●		●				20	5
DTR478-239	5	4.78	2.39	●	▲	●	●	●		●				25	5.5
DTR500-250	5	5	2.5	●	▲	●	●	●		●				25	5.5
DTR600-300	6	6	3	●	▲	●	●	●						25	5.5

● : New
● : Line up
▲ : To be discontinued

DTR

Profiling and undercutting

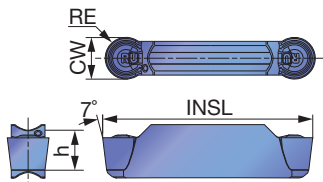

P	Steel	★	★	★	☆	☆		★				
M	Stainless	★		★	☆	★						
K	Cast iron	☆		★		☆	☆	☆				
N	Non-ferrous											
S	Superalloys			★	☆	★						
H	Hard materials											

★ : First choice
☆ : Second choice

Designation	Seat size	CW±0.05	RE	Coated					Cermets				INSL	h	
				New T9225	T9125	AH7025	AH725	AH905	GH130	NS9530					
DTR3-150	3	3	1.5	●	▲	●	●	●	●		●			20	5
DTR4-200	4	4	2	●	▲	●	●	●	●		●			20	5
DTR5-250	5	5	2.5	●	▲	●	●	●	●		●			25	5.5
DTR6-300	6	6	3	●	▲	●	●	●	●					25	5.5
DTR8-400	8	8	4	●	▲	●	●	●	●					30	6.7

● : New
● : Line up
▲ : To be discontinued

Reference pages: Toolholders → P.34 - 57, Standard cutting conditions → P.58

DGIS

Small diameter internal grooving

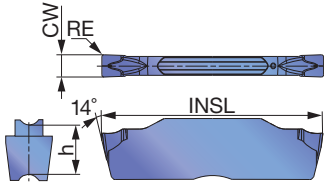

P	Steel	★	☆	★	☆	☆			★				
M	Stainless	★		★	☆	★							
K	Cast iron	☆		★		☆			☆				
N	Non-ferrous												
S	Superalloys			★	☆								
H	Hard materials												

★ : First choice
☆ : Second choice

Designation	Seat size	CW±0.05	RE	Coated					Cermets			INSL	h	
				New	T9225	T9125	AH7025	AH725	GH130	NS9530				
DGIS2-020	2	2	0.2	●	▲	●	●	●		●			20	5

● : New
● : Line up
▲ : To be discontinued

DTF

Face grooving and turning

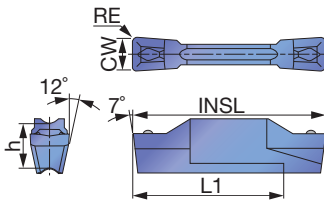

Right hand (R) shown.

P	Steel	★	☆	★	☆	☆			★				
M	Stainless	★		★	☆	★							
K	Cast iron	☆		★		☆			☆				
N	Non-ferrous												
S	Superalloys			★	☆								
H	Hard materials												

★ : First choice
☆ : Second choice

Designation	Seat size	HAND	CW±0.05	RE	Coated					Cermets			INSL	h	L1	
					New	T9225	T9125	AH7025	AH725	GH130	NS9530					
DTF3-040-R	3	R	3	0.4	●	▲	●	●	●		●			20	5	16
DTF3-040-L	3	L	3	0.4	●	▲	●	●	●		●			20	5	16
DTF4-040-R	4	R	4	0.4	●	▲	●	●	●		●			20	5	16
DTF4-040-L	4	L	4	0.4	●	▲	●	●	●		●			20	5	16

● : New
● : Line up
▲ : To be discontinued

Reference pages: DGIS: Toolholders → P.42, Standard cutting conditions → P.58

DTF : Toolholders → P.45 - 46, 55, Standard cutting conditions → P.58

DTA

Aluminium wheel machining (for high precision)

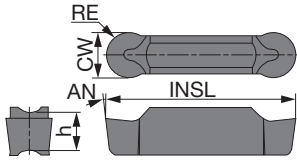

P	Steel								
M	Stainless								
K	Cast iron								
N	Non-ferrous	★							
S	Superalloys								
H	Hard materials								

★ : First choice
☆ : Second choice

Designation	Seat size	CW±0.02	RE	Uncoated							INSL	h	AN
				TH10									
DTA600-300	6	6	3	●							25	5.5	7°
DTA800-400	8	8	4	●							30	6.7	10°

●: Line up

SGN

External grooving of hardened steel

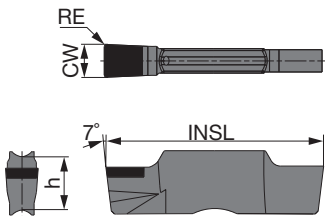

P	Steel								
M	Stainless								
K	Cast iron								
N	Non-ferrous								
S	Superalloys								
H	Hard materials	★							

★ : First choice
☆ : Second choice

Designation	Seat size	CW±0.025	RE	CBN							INSL	h
				BX360								
SGN200-020	2	2	0.2	●							20	5
SGN300-020	3	3	0.2	●							20	5
SGN400-020	4	4	0.2	●							20	5

●: Line up

Reference pages: DTA : Toolholders → [P.53](#), Standard cutting conditions → [P.58](#)

SGN : Toolholders → [P.34 - 57](#), Standard cutting conditions → [P.58](#)

CTER/L

External grooving, parting and turning toolholder

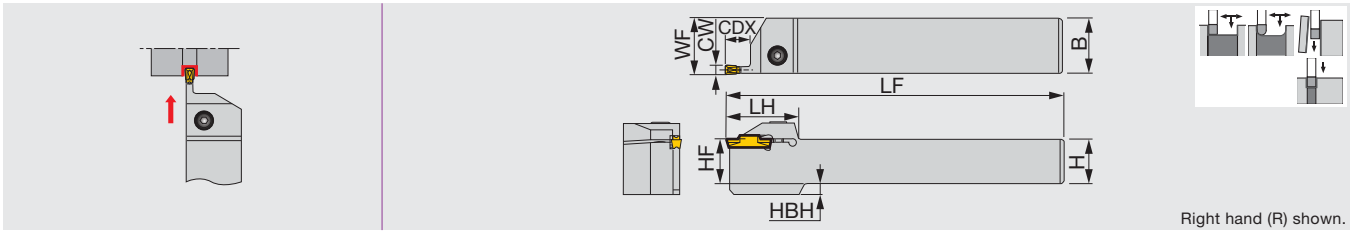

Designation	CW	Seat size	CDX	H	B	LF	LH	HF	WF ⁽¹⁾	HBH	Torque*
CTER/L1616-2T08	2	2	8	16	16	110	33	16	16.1	4	5
CTER/L2020-2T08	2	2	8	20	20	125	33	20	20.1	-	5
CTER/L2525-2T08	2	2	8	25	25	150	33	25	25.1	-	5
CTER/L1616-2T12	2	2	12	16	16	110	32	16	16.1	4	5
CTER/L2020-2T12	2	2	12	20	20	125	32	20	20.1	-	5
CTER/L2525-2T12	2	2	12	25	25	150	32	25	25.1	-	5
CTER/L1616-2T17	2	2	17	16	16	110	37	16	16.1	4	5
CTER/L2020-2T17	2	2	17	20	20	125	37	20	20.1	-	5
CTER/L2525-2T17	2	2	17	25	25	150	37	25	25.1	-	5
New CTER/L2525-2T20	2	2	20	25	25	150	38.5	25	25.1	-	5
CTER/L1616-3T09	3	3	9	16	16	110	32	16	16.3	4	5
CTER/L2020-3T09	3	3	9	20	20	125	32	20	20.3	-	5
CTER/L2525-3T09	3	3	9	25	25	150	32	25	25.3	-	5
New CTER/L1616-3T12	3	3	12	16	16	110	32	16	16.3	4	5
CTER/L2020-3T12	3	3	12	20	20	125	32	20	20.3	-	5
CTER/L2525-3T12	3	3	12	25	25	150	32	25	25.3	-	5
CTER/L1616-3T20	3	3	20	16	16	110	38.5	16	16.3	4	5
CTER/L2020-3T20	3	3	20	20	20	125	38.5	20	20.3	-	5
CTER/L2525-3T20	3	3	20	25	25	150	38.5	25	25.3	-	5
CTER/L2525-3T25	3	3	25	25	25	150	44.5	25	25.3	-	5
CTER/L1616-4T10	4	4	10	16	16	110	32	16	16.5	4	8.5
CTER/L2020-4T10	4	4	10	20	20	125	32	20	20.5	-	8.5
CTER/L2525-4T10	4	4	10	25	25	150	32	25	25.5	-	8.5
CTER/L2020-4T15	4	4	15	20	20	125	33	20	20.5	-	8.5
CTER/L2525-4T15	4	4	15	25	25	150	33	25	25.5	-	8.5
CTER/L1616-4T25	4	4	25	16	16	110	45	16	16.5	4	8.5
CTER/L2020-4T25	4	4	25	20	20	125	45	20	20.5	-	8.5
CTER/L2525-4T25	4	4	25	25	25	150	45	25	25.5	-	8.5
CTER/L3232-4T25	4	4	25	32	32	170	45	32	32.5	-	8.5
CTER/L2020-5T12	5	5	12	20	20	125	37	20	20.6	-	8.5
CTER/L2525-5T12	5	5	12	25	25	150	37	25	25.6	-	8.5
New CTER/L2525-5T17	5	5	17	25	25	150	37	25	25.6	-	8.5
CTER/L2525-5T20	5	5	20	25	25	150	37	25	25.6	-	8.5
CTER/L2525-5T32	5	5	32	25	25	150	56	25	25.6	-	8.5
CTER/L3232-5T32	5	5	32	32	32	170	56	32	32.6	-	8.5
CTER/L2020-6T12	6	6	12	20	20	125	37	20	20.6	-	12
CTER/L2525-6T12	6	6	12	25	25	150	37	25	25.6	7	12
New CTER/L2525-6T16	6	6	16	25	25	150	39	25	25.6	7	12
CTER/L2525-6T20	6	6	20	25	25	150	41	25	25.6	7	12
New CTER/L2525-6T25	6	6	25	25	25	150	47	25	25.6	7	12
CTER/L2525-6T32	6	6	32	25	25	150	56	25	25.6	7	12
CTER/L3232-6T32	6	6	32	32	32	170	56	32	32.6	-	12
CTER/L2525-8T16	8	8	16	25	25	150	47	25	26.1	7	12
CTER/L2525-8T25	8	8	25	25	25	150	47	25	26.1	7	12
CTER/L3232-8T25	8	8	25	32	32	170	47	32	33.1	-	12
New CTER/L3232-8T32	8	8	32	32	32	170	56	32	33.1	-	12
CTER/L2525-8T36	8	8	36	25	25	150	60	25	26.1	7	12
CTER/L3232-8T36	8	8	36	32	32	170	60	32	33.1	-	12

When groove depth is larger than (insert length - 1.5 mm), please use 1-cornered insert.

(1) "WF" value is calculated with groove width "CW" shown in the table.

*Torque: Recommended clamping torque (N·m)

SPARE PARTS



Designation	Clamping screw	Wrench
CTER/L1616-2T08	CM5X0.8X16-A	P-4
CTER/L2020-2T08	CM5X0.8X20-A	P-4
CTER/L2525-2T08	CM5X0.8X25-A	P-4
CTER/L1616-2T12	CM5X0.8X16-A	P-4
CTER/L2020-2T12	CM5X0.8X20-A	P-4
CTER/L2525-2T12	CM5X0.8X25-A	P-4
CTER/L1616-2T17	CM5X0.8X16-A	P-4
CTER/L2020-2T17	CM5X0.8X20-A	P-4
CTER/L2525-2T17	CM5X0.8X25-A	P-4
CTER/L2525-2T20	CM5X0.8X25-A	P-4
CTER/L1616-3T09	CM5X0.8X16-A	P-4
CTER/L2020-3T09	CM5X0.8X20-A	P-4
CTER/L2525-3T09	CM5X0.8X25-A	P-4
CTER/L1616-3T12	CM5X0.8X16-A	P-4
CTER/L2020-3T12	CM5X0.8X20-A	P-4
CTER/L2525-3T12	CM5X0.8X25-A	P-4
CTER/L1616-3T20	CM5X0.8X16-A	P-4
CTER/L2020-3T20	CM5X0.8X20-A	P-4
CTER/L2525-3T20	CM5X0.8X25-A	P-4
CTER/L2525-3T25	CM5X0.8X25-A	P-4
CTER/L1616-4T10	CM6X1X16-A	P-5
CTER/L2020-4T10	CM6X1X20-A	P-5
CTER/L2525-4T10	CM6X1X25-A	P-5
CTER/L2020-4T15	CM6X1X20-A	P-5
CTER/L2525-4T15	CM6X1X25-A	P-5
CTER/L1616-4T25	CM6X1X16-A	P-5
CTER/L2020-4T25	CM6X1X20-A	P-5
CTER/L2525-4T25	CM6X1X25-A	P-5
CTER/L3232-4T25	CM6X1X25-A	P-5
CTER/L2020-5T12	CM6X1X20-A	P-5
CTER/L2525-5T12	CM6X1X25-A	P-5
CTER/L2525-5T17	CM6X1X25-A	P-5
CTER/L2525-5T20	CM6X1X25-A	P-5
CTER/L2525-5T32	CM6X1X25-A	P-5
CTER/L3232-5T32	CM6X1X25-A	P-5
CTER/L2020-6T12	CM8X1.25X20-A	P-6
CTER/L2525-6T12	CM8X1.25X25-A	P-6
CTER/L2525-6T16	CM8X1.25X25-A	P-6
CTER/L2525-6T20	CM8X1.25X25-A	P-6
CTER/L2525-6T25	CM8X1.25X25-A	P-6
CTER/L2525-6T32	CM8X1.25X25-A	P-6
CTER/L3232-6T32	CM8X1.25X25-A	P-6
CTER/L2525-8T16	CM8X1.25X25-A	P-6
CTER/L2525-8T25	CM8X1.25X25-A	P-6
CTER/L3232-8T25	CM8X1.25X25-A	P-6
CTER/L3232-8T32	CM8X1.25X25-A	P-6
CTER/L2525-8T36	CM8X1.25X25-A	P-6
CTER/L3232-8T36	CM8X1.25X25-A	P-6

CTER/L-CHP

Mono-block external grooving and parting toolholder, with high pressure coolant capability

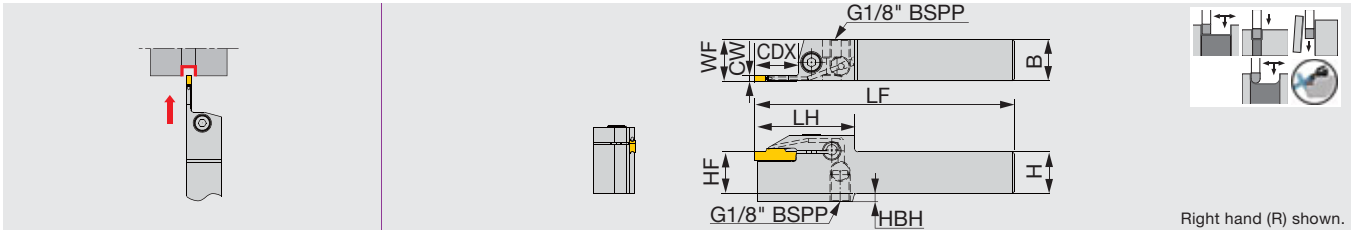

Right hand (R) shown.

Designation	CW	Seat size	CDX	H	B	LF	LH	HF	WF ⁽¹⁾	HBH	Torque*
CTER/L2020-2T17-CHP	2	2	17	20	20	125	45	20	20.1	4	5.5
CTER/L2525-2T17-CHP	2	2	17	25	25	150	45	25	25.1	-	5.5
CTER/L2020-3T20-CHP	3	3	20	20	20	125	48	20	20.3	4	5.5
CTER/L2525-3T20-CHP	3	3	20	25	25	150	48	25	25.3	-	5.5
CTER/L2525-3T25-CHP	3	3	25	25	25	150	51	25	25.3	-	5.5
CTER/L2525-4T25-CHP	4	4	25	25	25	150	55	25	25.5	-	8
CTER/L2525-5T20-CHP	5	5	20	25	25	150	49	25	25.58	-	8
CTER/L2525-6T20-CHP	6	6	20	25	25	150	52	25	25.58	7	12

When groove depth is larger than (insert length - 1.5 mm), please use 1-cornered insert.

(1) "WF" value is calculated with groove width "CW" shown in the table.

*Torque: Recommended clamping torque (N·m)

SPARE PARTS



Designation	Clamping screw	Wrench
CTER/L2020-2T17-CHP	CM5x0.8x20-A	P-4
CTER/L2525-2T17-CHP	CM5x0.8x25-A	P-4
CTER/L2020-3T20-CHP	CM5x0.8x20-A	P-4
CTER/L2525-3T20-CHP	CM5x0.8x25-A	P-4
CTER/L2525-3T25-CHP	CM5x0.8x25-A	P-4
CTER/L2525-4T25-CHP	CM6x1x16-A	P-5
CTER/L2525-5T20-CHP	CM6x1x16-A	P-5
CTER/L2525-6T20-CHP	CM8x1.25x20-A	P-6

Reference pages: Inserts → [P.20 - 33](#), Standard cutting conditions → [P.58](#)
Parts for coolant hose → [P.60](#)

CTEFR/L

External face grooving and turning toolholder

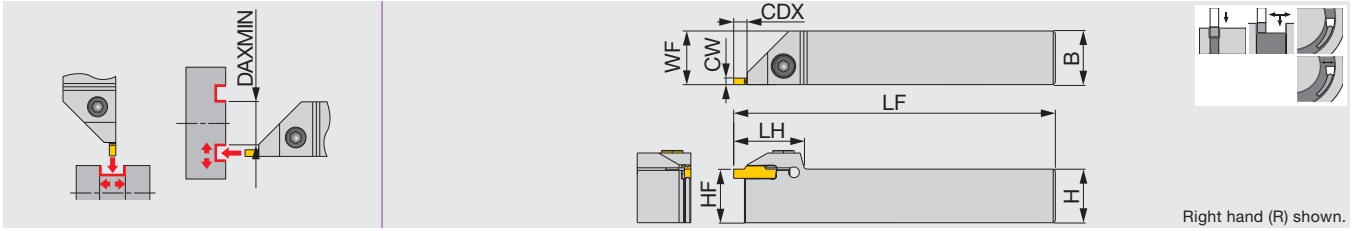

Right hand (R) shown.

Designation	CW	Seat size	CDX	H	B	LF	LH	HF	WF ⁽¹⁾	Torque*
CTEFR/L2020-4T04	4	2, 3, 4	4.8	20	20	125	33	20	20.5	8.5
CTEFR/L2525-4T04	4	2, 3, 4	4.8	25	25	150	33	25	25.5	8.5
CTEFR/L2020-6T04	6	5, 6	4.8	20	20	125	37	20	20.6	8.5
CTEFR/L2525-6T04	6	5, 6	4.8	25	25	150	37	25	25.6	8.5

(1) "WF" value is calculated with groove width "CW" shown in the table.
Use the right-hand insert for the right-hand holder with DTF insert.

*Torque: Recommended clamping torque (N·m)

SPARE PARTS



Designation	Clamping screw	Wrench
CTEFR/L2020-4T04	CM6X1X20-A	P-5
CTEFR/L2525-4T04	CM6X1X25-A	P-5
CTEFR/L2020-6T04	CM6X1X20-A	P-5
CTEFR/L2525-6T04	CM6X1X25-A	P-5

Insert	Groove width	Face grooving
	CW	Min. machining dia. DAXMIN
DGM / DGS / SGN	2	295
DGM / DGS / SGN / DGL	3	92
DGM / DGS / SGN / DGL	4	37
DGM / DGS / DGL	5	60
DGM / DGS / DGL	6	57
DTE / DGG / DTM	3	62
DTE / DGG / DTM	4	42
DTE / DGG / DTM	5	64
DTE / DGG / DTM	6	61

Insert	Groove width	Face grooving
	CW	Min. machining dia. DAXMIN
DTR	3	44
DTR	4	32
DTR	5	48
DTR	6	48
DTX	3	22
DTX	4	20
DTX	5	20
DTX	6	23
DTF	3	20
DTF	4	20

CGEUR/L

External 45° undercutting toolholder

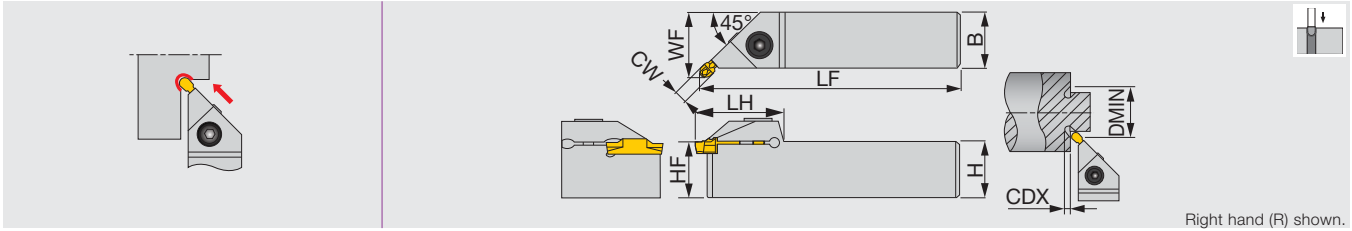

Designation	CW	DMIN	Seat size	CDX	H	B	LF	LH	HF	WF ⁽¹⁾	Insert	Torque*
CGEUR/L1616-3T02	3	32	3	2.8	16	16	110	30	16	19.3	DTIU...	5
CGEUR/L2020-3T02	3	32	3	2.8	20	20	125	30	20	23.3	DTIU...	5
CGEUR/L2525-3T02	3	32	3	2.8	25	25	150	30	25	28.3	DTIU...	5
CGEUR/L1616-4T02	4	32	4	2.8	16	16	110	31	16	19.5	DTIU...	8.5
CGEUR/L2020-4T02	4	32	4	2.8	20	20	125	31	20	23.5	DTIU...	8.5
CGEUR/L2525-4T02	4	32	4	2.8	25	25	150	31	25	28.5	DTIU...	8.5
CGEUR/L2525-6T03	6	34	5, 6	3.4	25	25	150	35	25	28.9	DTIU...	8.5

(1) "WF" value is calculated with groove width "CW" shown in the table.
 *Torque: Recommended clamping torque (N·m)

SPARE PARTS

Designation	Clamping screw	Wrench
CGEUR/L****-3T02	CM5X0.8X16-A	P-4
CGEUR/L1616-4T02	CM6X1X16-A	P-5
CGEUR/L2020-4T02	CM6X1X20-A	P-5
CGEUR/L2525-4T02/6T03	CM6X1X25-A	P-5

CAER/L-CHP

Modular-type external grooving and parting blade, with high pressure coolant capability

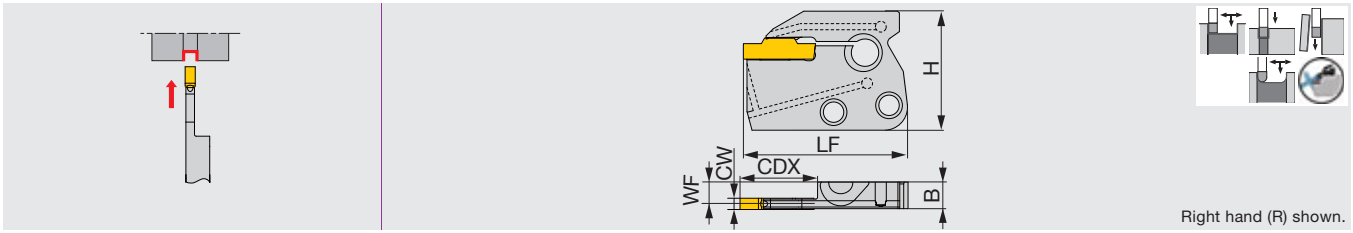

Right hand (R) shown.

Designation	CW	Seat size	CDX	H	B	LF	WF
CAER/L-2T16-CHP	2	2	16	33	7.2	41.5	6.3
CAER/L-2T20-CHP	2	2	20	33	7.2	45.5	6.3
CAER/L-3T16-CHP	3	3	16	33	7.2	41.5	5.9
CAER/L-3T20-CHP	3	3	20	33	7.2	45.5	6
CAER/L-4T16-CHP	4	4	16	33	7.2	41.5	5.7
CAER/L-4T20-CHP	4	4	20	33	7.2	45.5	5.7
CAER/L-5T20-CHP	5	5	20	33	7.2	46.3	5.3
CAER/L-6T20-CHP	6	6	20	33	7.2	46.3	4.8

When groove depth is larger than (insert length - 1.5 mm), please use 1-cornered insert.

New

CAEFR/L-CHP

Modular-type face and external grooving blade, with high pressure coolant capability

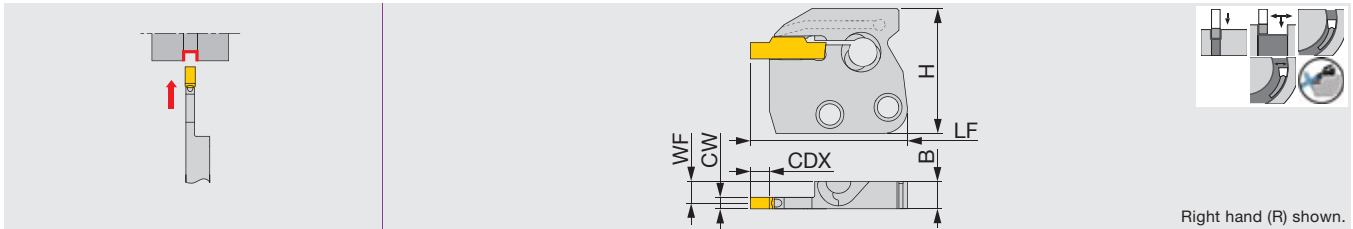

Right hand (R) shown.

Designation	CW	Seat size	CDX	H	B	LF	WF
CAEFR/L-4T04-CHP	4	2,3,4	4.8	33	7.2	41.5	5.7
CAEFR/L-6T04-CHP	6	5,6	4.8	33	7.2	46.3	4.775

Use the right-hand insert for the right-hand holder with DTF insert.

Insert	Groove width CW	Face grooving Min. machining dia. DAXMIN
DGM / DGS / SGN	2	295
DGM / DGS / SGN / DGL	3	92
DGM / DGS / SGN / DGL	4	37
DGM / DGS / DGL	5	60
DGM / DGS / DGL	6	57
DTE / DGG / DTM	3	62
DTE / DGG / DTM	4	42
DTE / DGG / DTM	5	64
DTE / DGG / DTM	6	61

Insert	Groove width CW	Face grooving Min. machining dia. DAXMIN
DTR	3	44
DTR	4	32
DTR	5	48
DTR	6	48
DTX	3	22
DTX	4	20
DTX	5	20
DTX	6	23
DTF	3	20
DTF	4	20

Reference pages: Inserts → **P.20 - 33**, Shank → **P.40 - 41**, Standard cutting conditions → **P.58**
Parts for coolant hose → **P.60**, Technical Reference → **P.59**

CHSR/L-CHP

Shank for CAER/L-CHP blades with high pressure coolant capability

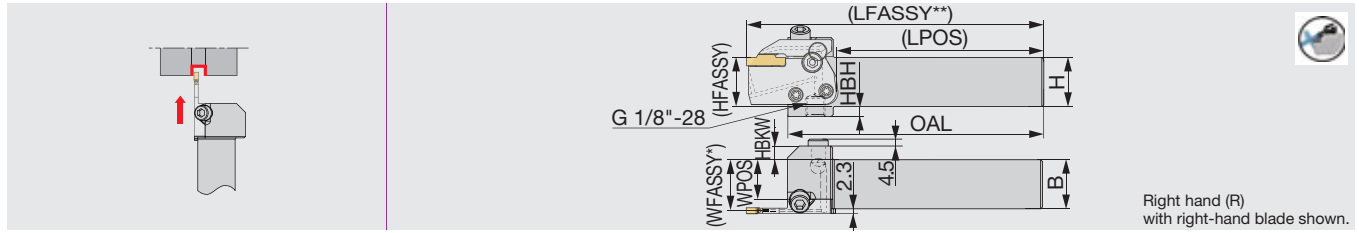

Designation	H	B	OAL	LPOS	WPOS	HBKW	HFASSY	HBH	Blade (Option)	Torque*
CHSR/L2020-CHP	20	20	130	105.5	15.1	12	20	10	CAER/L-CHP	5
CHSR/L2525-CHP	25	25	130	105.5	20.1	7	25	5	CAER/L-CHP	5

*WFASSY : Shank (WPOS) + blade (WF)
 **LFASSY : Shank (LPOS) + blade (LF)

*Please see the page L042 for the instruction on installing and removing the blade or the insert.
 *Torque: Recommended clamping torque (N-m)
 Note: Use right-hand blades (R) with right-hand shanks (R); and left-hand blades (L) with left-hand shanks (L).
 Applicable for 30 MPa coolant

SPARE PARTS

Designation	Clamping screw 1	Wrench 1	Clamping screw 2	Clamping screw 3	Wrench 2	O-ring	Plug
CHSR/L...-CHP	SRM5-04451	T-20/5	SRM6X12DIN6912	SRM6X20-XT	HW5.0	OR5X1N	PLUGG1/8ISO1179

Recommended clamping torque (N-m)

Clamping screw	Torque (N-m)
SRM5-04451	5
SRM6X12DIN6912	8.5
SRM6X20-XT	8.5

CHFVR/L-CHP

Shank for CAER/L-CHP blades with high pressure coolant capability

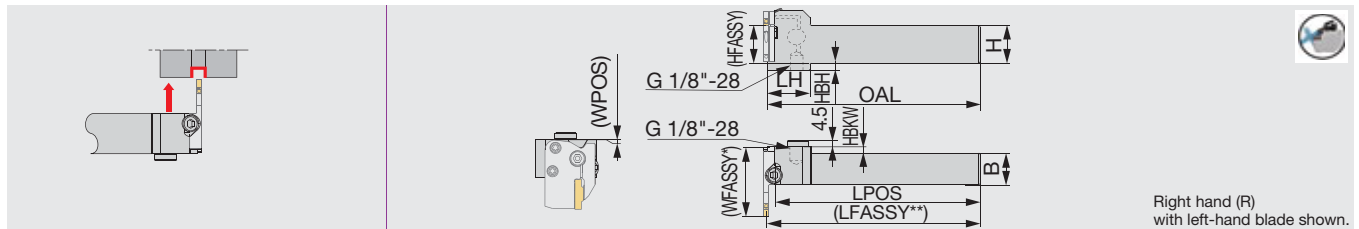

Designation	H	B	OAL	LH	LPOS	WPOS	HBKW	HFASSY	HBH	Blade (Option)	Torque*
CHFVR/L2020-CHP	20	20	140	28	135.1	0.5	5	20	10	CAER/L-CHP	5
CHFVR/L2525-CHP	25	25	140	28	135.1	0.5	0	25	5	CAER/L-CHP	5

*WFASSY : Shank (WPOS) + blade (WF)
 **LFASSY : Shank (LPOS) + blade (WF)

*Torque: Recommended clamping torque (N-m)
 Note: Use right-hand blades (R) with left-hand shanks (L); and left-hand blades (L) with right-hand shanks (R).
 Applicable for 30 MPa coolant

*Please see the page L042 for the instruction on installing and removing the blade or the insert.

SPARE PARTS

Designation	Clamping screw 1	Wrench 1	Clamping screw 2	Clamping screw 3	Wrench 2	O-ring	Plug
CHFVR/L...	SRM5-04451	T-20/5	SRM6X12DIN6912	SRM6X20-XT	HW5.0	OR5X1N	PLUGG1/8ISO1179

Recommended clamping torque (N-m)

Clamping screw	Torque (N-m)
SRM5-04451	5
SRM6X12DIN6912	8.5
SRM6X20-XT	8.5

Reference pages: Inserts → P.20 - 33, Blades → P.39, Standard cutting conditions → P.58
 Parts for coolant hose → P.60, Technical Reference → P.59

C*CHSN-CHP

TUNGCAP TUNGMSYSTEM^{MODULAR}

TungCap shank for CAER/L-CHP blades with high pressure coolant capability

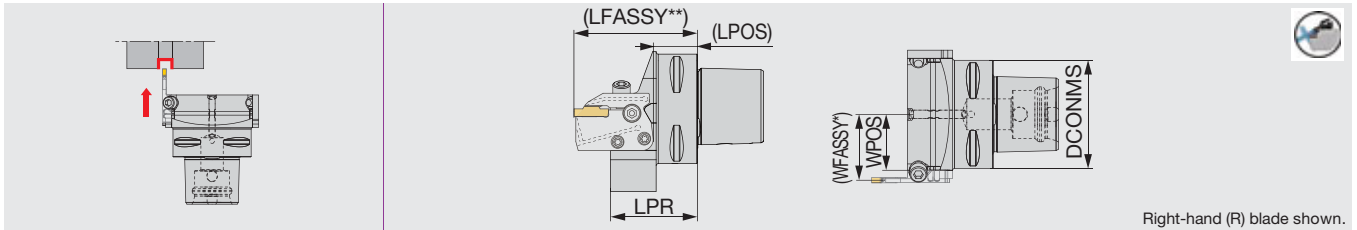

Right-hand (R) blade shown.

Designation	D(CONMS)	L(PR)	L(POS)	W(POS)	Blade (Option)	Torque*
C3CHSN19045-CHP	32	45	17.5	18.5	CAER/L...-CHP	5
C4CHSN21047-CHP	40	46.5	21.5	21	CAER/L...-CHP	5
C5CHSN26047-CHP	50	47	22.5	26	CAER/L...-CHP	5
C6CHSN33050-CHP	63	50	24.5	32.5	CAER/L...-CHP	5

*W(FASSY) : Shank (W(POS)) + blade (W(F))

**L(FASSY) : Shank (L(POS)) + blade (L(F))

*Torque: Recommended clamping torque (N·m)

Applicable for 30 MPa coolant

*Please see the page L042 for the instruction on installing and removing the blade or the insert.

SPARE PARTS



Designation	Clamping screw 1	Wrench 1	Clamping screw 2	Clamping screw 3	Wrench 2	O-ring
C*CHSN...-CHP	SRM5-04451	T-20/5	SRM6X12DIN6912	SRM6X20-XT	HW5.0	OR5X1N

Recommended clamping torque (N·m)

Clamping screw	Torque (N·m)
SRM5-04451	5
SRM6X12DIN6912	8.5
SRM6X20-XT	8.5

C*CHFVN-CHP

TUNGCAP TUNGMSYSTEM^{MODULAR}

TungCap shank for CAER/L-CHP blades with high pressure coolant capability

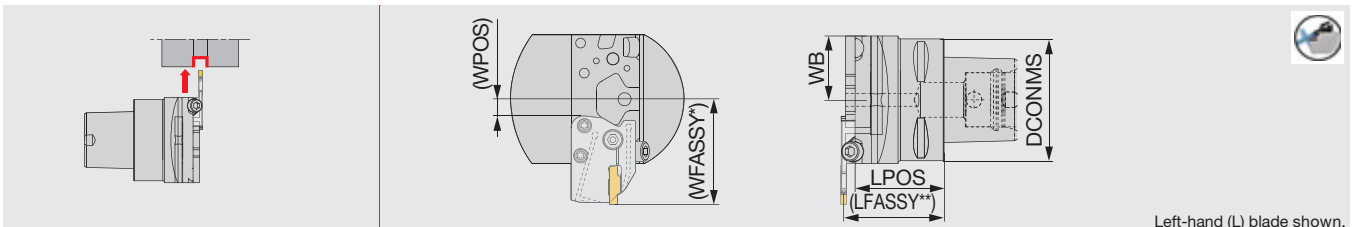

Left-hand (L) blade shown.

Designation	D(CONMS)	L(POS)	W(B)	W(POS)	Blade (Option)	Torque*
C3CHFVN26040-CHP	32	40	26	1.5	CAER/L...-CHP	5
C4CHFVN26046-CHP	40	46	26	1.5	CAER/L...-CHP	5
C5CHFVN26046-CHP	50	46	26	1.5	CAER/L...-CHP	5
C6CHFVN33046-CHP	63	46	33	8.5	CAER/L...-CHP	5

*W(FASSY) : Shank (W(POS)) + blade (L(F))

**L(FASSY) : Shank (L(POS)) + blade (W(F))

*Torque: Recommended clamping torque (N·m)

Applicable for 30 MPa coolant

*Please see the page L042 for the instruction on installing and removing the blade or the insert.

SPARE PARTS



Designation	Clamping screw 1	Wrench 1	Clamping screw 2	Clamping screw 3	Wrench 2	O-ring
C*CHFVN...-CHP	SRM5-04451	T-20/5	SRM6X12DIN6912	SRM6X20-XT	HW5.0	OR5X1N

Recommended clamping torque (N·m)

Clamping screw	Torque (N·m)
SRM5-04451	5
SRM6X12DIN6912	8.5
SRM6X20-XT	8.5

Reference pages: Inserts → P.20 - 33, Blades → P.39, Standard cutting conditions → P.58
 Technical Reference → P.59

CTIR/L

Internal grooving and turning toolholder

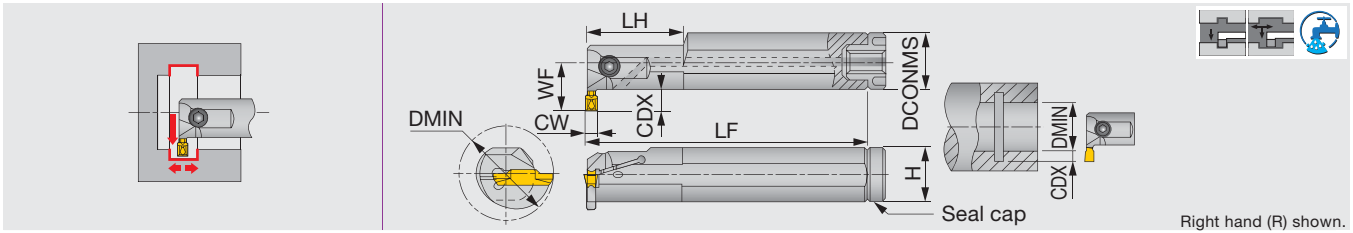

Designation	CW	DMIN	Seat size	CDX	DCONMS	H	LF ⁽¹⁾	LH	WF	Insert	Torque*
CTIR/L16-2T08-D250	2	25	2	8	16	14	125	-	16.5	DGIM..., DGIS...	5
CTIR/L20-2T06-D250	2	25	2	6	20	18	160	40	15.8	DGIM..., DGIS...	5
CTIR/L20-3T06-D250	3	25	3	6	20	18	160	40	15.8	DTI..., DTX...	5
CTIR/L25-3T05-D250	3	25	3	5.1	25	23	200	40	17.5	DTI..., DTX...	5
CTIR/L25-3T08-D320	3	32	3	8	25	23	200	40	21.5	DTI..., DTX...	5
CTIR/L32-3T10-D400	3	40	3	10	32	30	250	60	27	DTI..., DTX...	5
CTIR/L20-4T06-D250	4	25	4	6	20	18	160	40	15.8	DTI..., DTX...	5
CTIR/L25-4T08-D320	4	32	4	8	25	23	200	40	21.5	DTI..., DTX...	5
CTIR/L32-4T04-D310	4	31	4	4	32	30	250	60	20.8	DTI..., DTX...	5
CTIR/L32-4T10-D400	4	40	4	10	32	30	250	60	27	DTI..., DTX...	5
CTIR/L25-5T05-D310	5	31	5	5	25	23	200	60	17.3	DTI..., DTX...	8.5
CTIR/L32-5T10-D400	5	40	5	10	32	30	250	60	27	DTI..., DTX...	8.5
CTIR/L32-6T04-D310	6	31	6	4	32	30	250	60	20.8	DTI..., DTX...	8.5
CTIR/L32-6T10-D400	6	40	6	10	32	30	250	60	27	DTI..., DTX...	8.5
CTIR/L32-8T05-D370	8	37	8	5	32	30	250	60	21.3	DTI..., DTX...	8.5
CTIR/L40-8T05-D420	8	42	8	5.8	40	38	300	65	25.8	DTI..., DTX...	8.5

(1) L1 is calculated with the groove width CW in the above table.
*Torque: Recommended clamping torque (N·m)

SPARE PARTS



Designation	Clamping screw	Wrench	Seal cap	Thread type for connection
CTIR/L16-2T08-D250	CM5X0.8X10-A	P-4	CA-16	M6
CTIR/L20-2T06-D250	CM5X0.8X12-A	P-4	CA-20	M6
CTIR/L20-3T06-D250	CM5X0.8X12-A	P-4	CA-20	M6
CTIR/L25-3T05-D250	CM5X0.8X16-A	P-4	CA-25	R1/8"
CTIR/L25-3T08-D320	CM5X0.8X16-A	P-4	CA-25	R1/8"
CTIR/L32-3T10-D400	CM5X0.8X16-A	P-4	CA-32	R1/8"
CTIR/L20-4T06-D250	CM5X0.8X12-A	P-4	CA-20	M6
CTIR/L25-4T08-D320	CM5X0.8X16-A	P-4	CA-25	R1/8"
CTIR/L32-4T04-D310	CM5X0.8X16-A	P-4	CA-32	R1/8"
CTIR/L32-4T10-D400	CM5X0.8X16-A	P-4	CA-32	R1/8"
CTIR/L25-5T05-D310	CM6X1X16-A	P-5	CA-25	R1/8"
CTIR/L32-5T10-D400	CM6X1X20-A	P-5	CA-32	R1/8"
CTIR/L32-6T04-D310	CM6X1X20-A	P-5	CA-32	R1/8"
CTIR/L32-6T10-D400	CM6X1X20-A	P-5	CA-32	R1/8"
CTIR/L32-8T05-D370	CM6X1X20-A	P-5	CA-32	R1/8"
CTIR/L40-8T05-D420	CM6X1X25-A	P-5	CA-40	R1/8"

When using the inserts that are not in the above

INSERT	Groove width		Min. diameter DMIN
	CW		
DGM / DGS / SGN / DGL / DTM	3		50
DGM / DGS / SGN / DTM / DGL	4		50
DGM / DGS / DTM / DGL	5		60
DGM / DGS / DTM / DGL	6		60
DGM / DGS / DTM	8		70
DTE / DGG	3		40
DTE / DGG	4		40
DTE / DGG	5		50
DTE / DGG	6		50
DTE / DGG	8		62
DTR	3		38
DTR	4		38
DTR	5		43
DTR	6		46
DTR	8		56

Reference pages: Inserts → **P.20 - 33**, Standard cutting conditions → **P.58**

CTIFR/L

External/Internal face grooving and turning toolholder

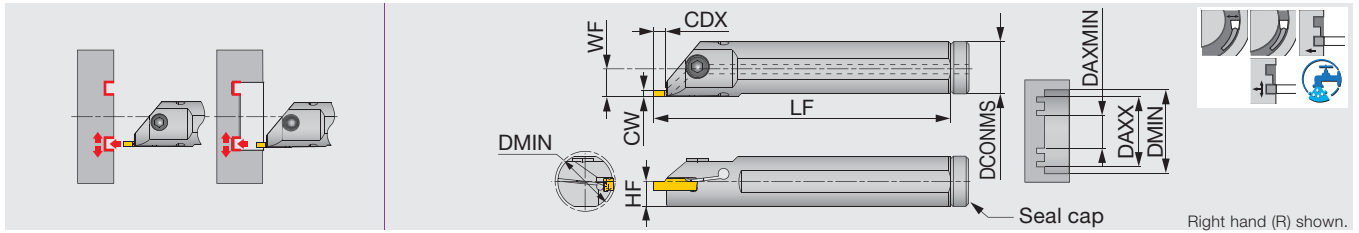

Designation	CW	Seat size	CDX	DCONMS	LF ⁽¹⁾	HF	WF ⁽¹⁾	Torque*
CTIFR/L25-4T05-D270	4	3, 4	5.5	25	200	11.5	13.3	5
CTIFR/L32-4T05-D340	4	3, 4	5.5	32	250	15	16.8	5
CTIFR/L25-5T05-D270	6	5, 6	5.5	25	200	11.5	13.3	5
CTIFR/L32-5T05-D340	6	5, 6	5.5	32	250	15	16.8	5

(1) f is calculated with the groove width W in the above table.
Use the right-hand insert for the right-hand holder with DTF insert.
*Torque: Recommended clamping torque (N·m)

SPARE PARTS

Designation	Clamping screw	Wrench	Seal cap
CTIFR/L25-4T05-D270	CM6X1X16-A	P-5	CA-25
CTIFR/L32-4T05-D340	CM6X1X20-A	P-5	CA-32
CTIFR/L25-5T05-D270	CM6X1X16-A	P-5	CA-25
CTIFR/L32-5T05-D340	CM6X1X20-A	P-5	CA-32

Seat size	Min. machining dia	
	DCONMS = 25 mm	DCONMS = 32 mm
3	26.3	33.3
4	26.8	33.8
5	26.3	33.3
6	26.8	33.8

Insert	Groove width CW	Face grooving
		Min. machining dia. DAXMIN
DGM / DGS / SGN / DGL	3	92
DGM / DGS / SGN / DGL	4	37
DGM / DGS / DGL	5	60
DGM / DGS / DGL	6	57
DTE / DGG / DTM	3	62
DTE / DGG / DTM	4	42
DTE / DGG / DTM	5	64
DTE / DGG / DTM	6	61

Insert	Groove width CW	Face grooving
		Min. machining dia. DAXMIN
DTR	3	44
DTR	4	32
DTR	5	48
DTR	6	48
DTX	3	22
DTX	4	20
DTX	5	20
DTX	6	23
DTF	3	20
DTF	4	20

CGIUR/L

Internal 45° undercutting toolholder

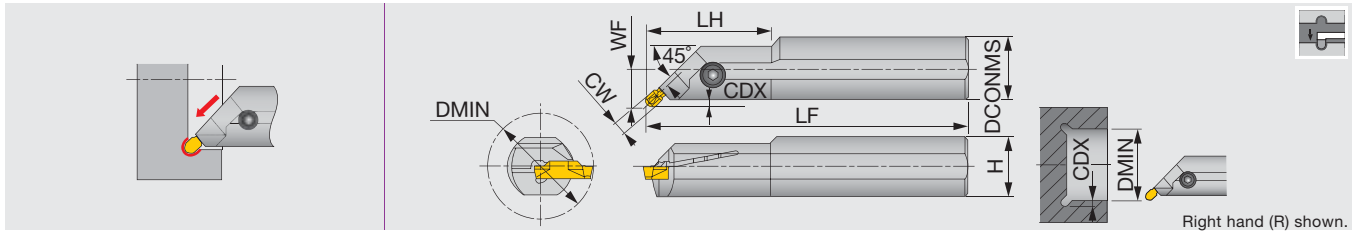

Right hand (R) shown.

Designation	CW	DMIN	Seat size	CDX	DCONMS	H	LF	LH	WF ⁽¹⁾	Insert	Torque*
CGIUR/L20-3T02-D380	3	38	3	2.8	20	19	160	-	12.8	DTIU...	5
CGIUR/L25-3T02-D380	3	38	3	2.8	25	23	200	40	14.8	DTIU...	5
CGIUR/L20-4T02-D380	4	38	4	2.8	20	19	160	-	12.9	DTIU...	5
CGIUR/L25-4T02-D460	4	46	4	2.8	25	23	200	40	14.9	DTIU...	5
CGIUR/L25-6T02-D460	6	46	5, 6	2.8	25	23	200	-	15.2	DTIU...	8.5

(1) WF is calculated with the groove width CW in the above table.

*Torque: Recommended clamping torque (N·m)

SPARE PARTS

Designation	Clamping screw	Wrench
CGIUR/L20-3T02-D380	CM5X0.8X12-A	P-4
CGIUR/L25-3T02-D380	CM5X0.8X16-A	P-4
CGIUR/L*-4T02-D...	CM5X0.8X16-A	P-4
CGIUR/L25-6T02-D460	CM6X1X25-A	P-5

CTFR/L

Face grooving and turning toolholder

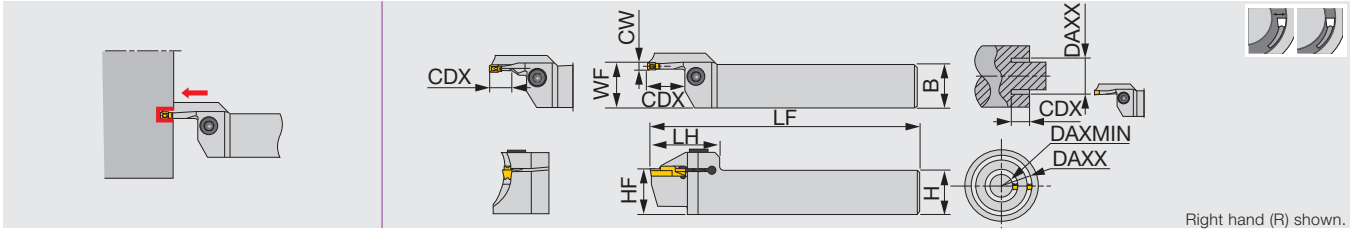

Designation	CW	DAXMIN	DAXX	Seat size	CDX	H	B	LF	LH	HF	WF ⁽¹⁾	Torque*
CTFR/L2525-3T10-024035	3	24	35	3	10	25	25	150	38	25	25.5	5
CTFR/L2525-3T10-029040	3	29	40	3	10	25	25	150	38	25	25.5	5
CTFR/L2525-3T10-034050	3	34	50	3	10	25	25	150	38	25	25.5	5
CTFR/L2525-3T15-044070	3	44	70	3	15	25	25	150	38	25	25.5	5
CTFR/L2525-3T15-064100	3	64	100	3	15	25	25	150	38	25	25.5	5
CTFR/L2525-4T10-022036	4	22	36	4	10	25	25	150	39	25	25.6	5
CTFR/L2525-4T20-028042	4	28	42	4	20	25	25	150	39	25	25.6	5
CTFR/L2525-4T20-034050	4	34	50	4	20	25	25	150	39	25	25.6	5
CTFR/L2525-4T20-042070	4	42	70	4	20	25	25	150	39	25	25.6	5
CTFR/L2525-4T20-062120	4	62	120	4	20	25	25	150	39	25	25.6	5
CTFR/L2525-4T20-112200	4	112	200	4	20	25	25	150	39	25	25.6	5
CTFR/L2525-5T25-050080	5	50	80	5	25	25	25	150	49	25	25.6	12
CTFR/L2525-5T25-070110	5	70	110	5	25	25	25	150	49	25	25.6	12
CTFR/L2525-5T25-100150	5	100	150	5	25	25	25	150	49	25	25.6	12
CTFR/L2525-5T25-140200	5	140	200	5	25	25	25	150	49	25	25.6	12
CTFR/L2525-6T25-048070	6	48	70	6	25	25	25	150	49	25	25.6	12
CTFR/L2525-6T25-058100	6	58	100	6	25	25	25	150	49	25	25.6	12
CTFR/L2525-6T25-088180	6	88	180	6	25	25	25	150	49	25	25.6	12
CTFR/L2525-6T25-168400	6	168	400	6	25	25	25	150	49	25	25.6	12

When depth is deeper than (insert length - 1.5 mm), 1 corner type is recommended.
Max. groove depth will be 15 mm with DTF insert.

Use the right-hand insert for the right-hand holder with DTF insert.

(1)WF is calculated with the groove width (CW) in the above table.

*Torque:Recommended torque (N·m)

SPARE PARTS

Designation	Clamping screw	Wrench
CTFR/L2525-3T - 4T...	CM6X1X25-A	P-5
CTFR/L2525-5T - 6T...	CM8X1.25X25-A	P-6

INSERT

Designation	Seat size	Insert
CTFR/L2525-3T10-024035	3	DTF, DTX
CTFR/L2525-3T10-029040	3	DTF, DTX
CTFR/L2525-3T10-034050	3	DTF, DTX
CTFR/L2525-3T15-044070	3	DTF, DTX, DTR, DTE, DGG, DTM
CTFR/L2525-3T15-064100	3	DTF, DTX, DTE, DGG, DGM, DGS, DTR, SGN, DGL, DTM
CTFR/L2525-4T10-022036	4	DTF, DTX
CTFR/L2525-4T20-028042	4	DTF, DTX, DTR
CTFR/L2525-4T20-034050	4	DTF, DTX, DTE, DGG, DGM, DGS, DTR, DTM, DGL
CTFR/L2525-4T20-042070	4	DTF, DTX, DTE, DGG, DGM, DGS, DTR, SGN, DTM, DGL
CTFR/L2525-4T20-062120	4	DTF, DTX, DTE, DGG, DGM, DGS, DTR, SGN, DTM, DGL
CTFR/L2525-4T20-112200	4	DTF, DTX, DTE, DGG, DGM, DGS, DTR, SGN, DTM, DGL
CTFR/L2525-5T25-...	5	DTX, DTE, DGG, DGM, DGS, DTR, DTM, DGL
CTFR/L2525-6T25-...	6	DTX, DTE, DGG, DGM, DGS, DTR, DTM, DGL

Insert	Groove width CW	Face grooving Min. machining dia. DAXMIN
DGM / DGS / SGN / DGL	3	92
DGM / DGS / SGN / DGL	4	37
DGM / DGS / DGL	5	60
DGM / DGS / DGL	6	57
DTE / DGG / DTM	3	62
DTE / DGG / DTM	4	42
DTE / DGG / DTM	5	64
DTE / DGG / DTM	6	61
DTR	3	44
DTR	4	32
DTR	5	48
DTR	6	48
DTX	3	22
DTX	4	20
DTX	5	20
DTX	6	23
DTF	3	20
DTF	4	20

Reference pages: Inserts → **P.20 - 33**, Standard cutting conditions → **P.58**

CTFVR/L

Perpendicular toolholder for face grooving and turning

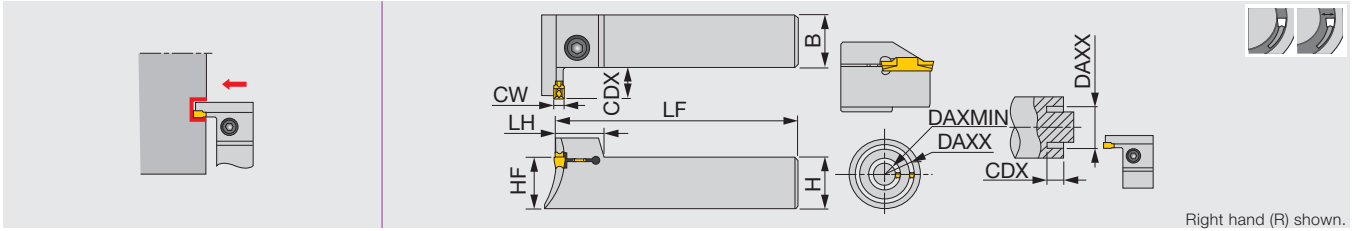

Designation	CW	DAXMIN	DAXX	Seat size	CDX	H	B	LF	LH	HF	Torque*
CTFVR/L2525-3T10-024035	3	24	35	3	10	25	25	150	18	25	5
CTFVR/L2525-3T10-029040	3	29	40	3	10	25	25	150	18	25	5
CTFVR/L2525-3T10-034050	3	34	50	3	10	25	25	150	18	25	5
CTFVR/L2525-3T15-044060	3	44	60	3	15	25	25	150	18	25	5
CTFVR/L2525-3T15-054085	3	54	85	3	15	25	25	150	18	25	5
CTFVR/L2525-4T12-022040	4	22	40	4	12	25	25	150	18.5	25	8.5
CTFVR/L2525-4T15-032050	4	32	50	4	15	25	25	150	18.5	25	8.5
CTFVR/L2525-4T15-042060	4	42	60	4	15	25	25	150	18.5	25	8.5
CTFVR/L2525-4T15-052085	4	52	85	4	15	25	25	150	18.5	25	8.5
CTFVR/L2525-5T20-050080	5	50	80	5	20	25	25	150	22	25	12
CTFVR/L2525-5T20-070110	5	70	110	5	20	25	25	150	22	25	12
CTFVR/L2525-5T20-100150	5	100	150	5	20	25	25	150	22	25	12
CTFVR/L2525-5T20-140200	5	140	200	5	20	25	25	150	22	25	12
CTFVR/L2525-6T20-048085	6	48	85	6	20	25	25	150	22	25	12
CTFVR/L2525-6T20-073150	6	73	150	6	20	25	25	150	22	25	12
CTFVR/L2525-6T20-138250	6	138	250	6	20	25	25	150	22	25	12

When depth is deeper than (insert length - 1.5 mm), 1 corner type is recommended
 Max. groove depth will be 15 mm with DTF insert.
 Use the right-hand insert for the right-hand holder with DTF insert.
 *Torque: Recommended torque (N·m)

SPARE PARTS

Designation	Clamping screw	Wrench
CTFVR/L2525-3T...	CM5X0.8X25-A	P-4
CTFVR/L2525-4T...	CM6X1X25-A	P-5
CTFVR/L2525-5T..., 6T...	CM8X1.25X25-A	P-6

INSERT

Designation	Seat size	Insert
CTFVR/L2525-3T10-024035	3	DTF, DTX
CTFVR/L2525-3T10-029040	3	DTF, DTX
CTFVR/L2525-3T10-034050	3	DTF, DTX, DTR
CTFVR/L2525-3T15-044060	3	DTF, DTX, DTE, DTR
CTFVR/L2525-3T15-054085	3	DTF, DTX, DTE, DGG, DTR, DTM
CTFVR/L2525-4T12-022040	4	DTF, DTX, DTR
CTFVR/L2525-4T15-032050	4	DTF, DTX, DTE, DGG, DGM, DGS, DTR, DTM, DGL
CTFVR/L2525-4T15-042060	4	DTF, DTX, DTE, DGG, DGM, DGS, DTR, SGN, DTM, DGL
CTFVR/L2525-4T15-052085	4	DTF, DTX, DTE, DGG, DGM, DGS, DTR, SGN, DTM, DGL
CTFVR/L2525-5T20-...	5	DTX, DTE, DGG, DGM, DGS, DTR, DTM, DGL
CTFVR/L2525-6T20-...	6	DTX, DTE, DGG, DGM, DGS, DTR, DTM, DGL

Insert	Groove width CW	Face grooving Min. machining dia. DAXMIN
DGM / DGS / SGN / DGL	3	92
DGM / DGS / SGN / DGL	4	37
DGM / DGS / DGL	5	60
DGM / DGS / DGL	6	57
DTE / DGG / DTM	3	62
DTE / DGG / DTM	4	42
DTE / DGG / DTM	5	64
DTE / DGG / DTM	6	61
DTR	3	44
DTR	4	32
DTR	5	48
DTR	6	48
DTX	3	19
DTX	4	20
DTX	5	20
DTX	6	23
DTF	3	19
DTF	4	20

Reference pages: Inserts → **P.20 - 33**, Standard cutting conditions → **P.58**

JCTER/L

External grooving and parting toolholder, for Swiss lathes

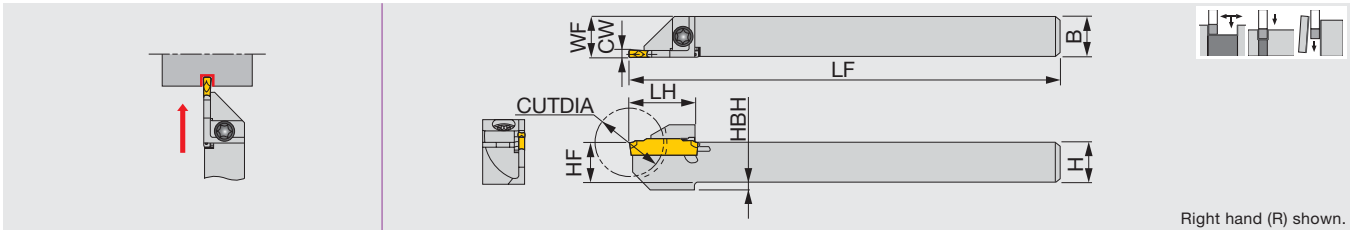

Designation	CW	Seat size	CUTDIA	H	B	LF	LH	HF	WF ⁽¹⁾	HBH	Torque*
JCTER/L1010X1.4T10	1.4	1	20	10	10	120	18	10	10.2	-	3
JCTER1010-1.4T10	1.4	1	20	10	10	125	18	10	10.2	-	3
JCTER/L1212F1.4T12	1.4	1	24	12	12	85	19.5	12	12.2	-	3
JCTER/L1212X1.4T12	1.4	1	24	12	12	120	19.5	12	12.2	-	3
JCTER1212-1.4T12	1.4	1	24	12	12	125	19.5	12	12.2	-	3
JCTER/L1414-1.4T12	1.4	1	24	14	14	125	19.5	14	14.2	-	3
JCTER/L1616X1.4T16	1.4	1	32	16	16	120	24	16	16.2	-	3
JCTER/L1010X2T10	2	2	20	10	10	120	19	10	10.1	2	3
JCTER/L1212F2T12	2	2	24	12	12	85	19	12	12.1	2	3
JCTER/L1212X2T12	2	2	24	12	12	120	19	12	12.1	2	3
JCTER/L1414-2T12	2	2	24	14	14	125	19	14	14.1	-	3
JCTER/L1616X2T16	2	2	32	16	16	120	24	16	16.1	-	3
JCTER/L1212F3T12	3	3	24	12	12	85	19	12	12.3	2	3
JCTER/L1212X3T12	3	3	24	12	12	120	19	12	12.3	2	3
JCTER/L1616X3T16	3	3	32	16	16	120	24	16	16.3	-	3
JCTER/L2020H3T16	3	3	32	20	20	100	24	20	20.3	-	3

(1) "WF" value is calculated with groove width "CW" shown in the table. • CUTDIA: Max. parting diameter
*Torque: Recommended clamping torque (N-m)

SPARE PARTS

Designation	Clamping screw	Wrench
JCTER/L...	CSHB-4-A	T-15F

New

JCTER/L2012

External grooving and parting toolholder, for Swiss lathes

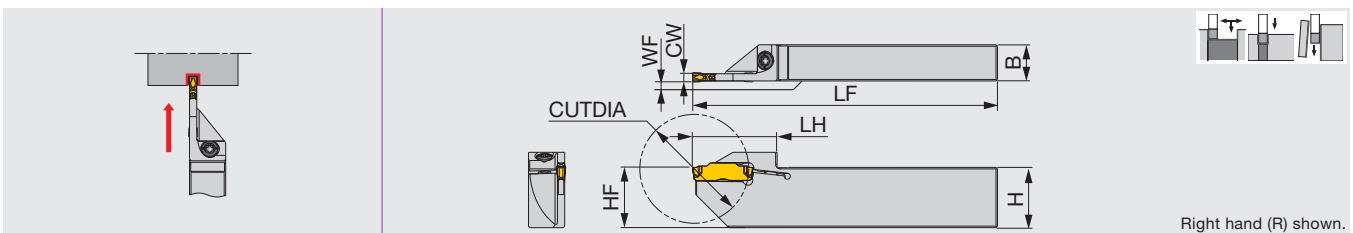

Designation	CW	Seat size	CUTDIA	H	B	LF	LH	HF	WF ⁽¹⁾	Torque*
JCTER/L2012H2T18	2	2	36	20	12	100	25	20	0.1	3
JCTER/L2012H3T21	3	3	42	20	12	100	28	20	0.3	3

(1) "WF" value is calculated with groove width "CW" shown in the table. • CUTDIA: Max. parting diameter
*Torque: Recommended clamping torque (N-m)

SPARE PARTS

Designation	Clamping screw	Wrench
JCTER/L2012...	CSHB-4-A	T-15F

Reference pages: Inserts → **P.20 - 33**, Standard cutting conditions → **P.58**

JCTER/L-CHP

External grooving and parting toolholder with DirectTungJet connection

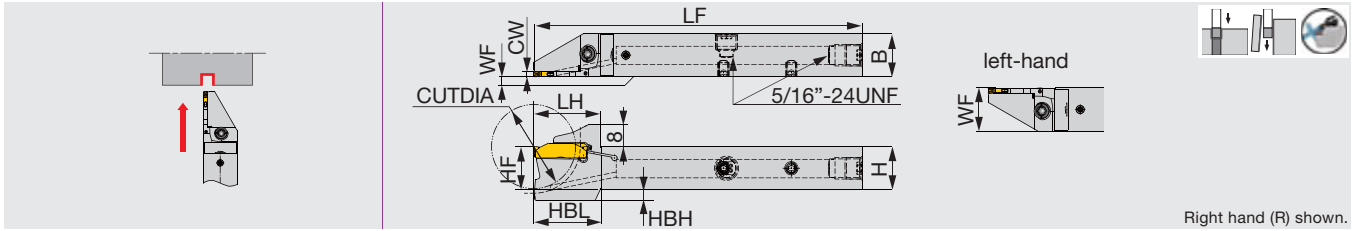

Designation	CW	Seat size	CUTDIA	H	B	LF	LH	HF	WF ⁽¹⁾	HBH	HBL	Torque*
JCTER/L1212X2T12-CHP	2	2	25	12	12	120	24.7	12	0/12	5	24.7	3
JCTER/L1616X2T12-CHP	2	2	25	16	16	120	24.7	16	0/16	1	24.5	3
JCTER/L1616X2T16-CHP	2	2	32	16	16	120	24.7	16	0/16	4	24.7	3
JCTER/L2020X2T16-CHP	2	2	32	20	20	120	24.7	20	0/20	-	-	3

(1) "WF" value is calculated with groove width "CW" shown in the table. "WF" value depends on the tool hand. With 0/12, WF is 0 for the right hand and 12 for the left hand.
 • CUTDIA: Max. parting diameter *Torque: Recommended clamping torque (N·m)

SPARE PARTS

Designation	Clamping screw	Wrench 1	Coolant plug	Wrench 2	DirectJet plug	Wrench 3
JCTER/L...	C SHB-4-A	T-15F	SR5/16UNFTL360	P-4	SSHM4-6-TB	P-2

Groove width: 2.0 mm

CGER/L

External deep grooving and parting toolholder, for Swiss lathes

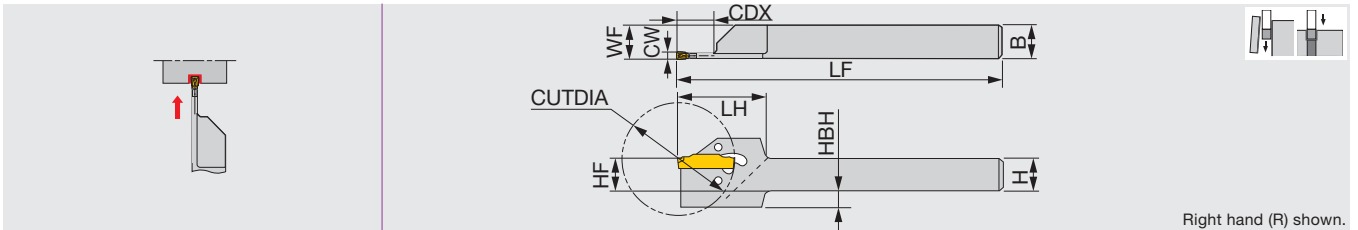

Designation	CW	Seat size	CUTDIA ⁽¹⁾	CDX	H	B	LF	LH	HF	WF ⁽²⁾	HBH
CGER/L2020-1.4T14	1.4	1	29/29	9.7	20	20	125	31	20	20.2	-
CGER/L1212-2T17	2	2	35/35	11.8	12	12	150	31	12	12.1	6
CGER/L1616-2T17	2	2	35/35	11.8	16	16	150	31	16	16.1	2
CGER/L2020-2T17	2	2	35/35	9.8	20	20	125	31	20	20.1	-
CGER/L1212-3T19	3	3	38/40	12	12	12	150	31	12	12.3	6
CGER/L1616-3T19	3	3	38/45	14.9	16	16	150	31	16	16.3	2
CGER/L2020-3T19	3	3	38/45	13.2	20	20	125	31	20	20.3	-
CGER/L2020-4T19	4	4	38/55	20.3	20	20	125	33	20	20.4	-

• Wrench (CRW**) is not included. Please order it separately. Insert is clamped by the elastic deformation of the upper jaw.
 (1) DG*/SG* maximum parting diameter will depend on the insert. (2) "WF" value is calculated with groove width "CW" shown in the table.

SPARE PARTS

Designation	Wrench (Option)
CGER/L2020-1.4T14	CRW23
CGER/L****-2T17 - 4T19	CRW33

Reference pages: Inserts → **P.20 - 33**, Standard cutting conditions → **P.58**
 Parts for coolant hose → **P.60**

New

CGP32-CHP

External deep grooving and parting blade, with high pressure coolant capability

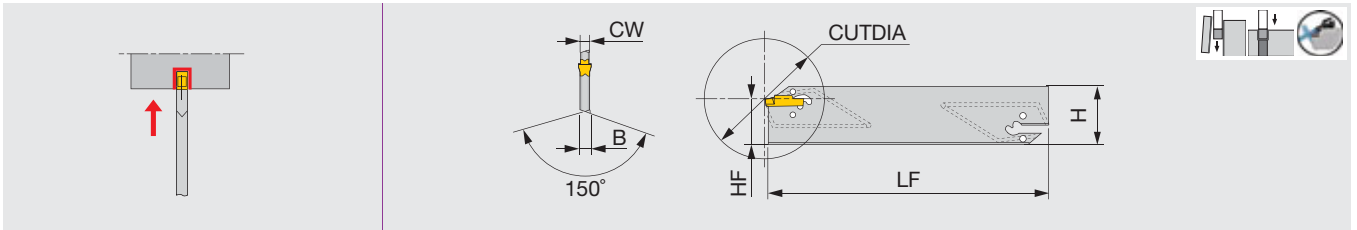

Designation	CW	Seat size	CUTDIA	H	B	LF	HF
CGP32-2D-CHP	2	2	50	32	1.8	150	24.8
CGP32-3D-CHP	3	3	100	32	2.4	150	24.8
CGP32-4D-CHP	4	4	100	32	3.2	150	24.9
CGP32-5D-CHP	5	5	120	32	4	150	24.9
CGP32-6D-CHP	6	6	120	32	5.2	150	24.9

When depth is deeper than (insert length - 1.5mm), 1 corner type is recommended.

- CUTDIA Max. parting dia
- Wrench (CRW...) is not included. Please order it separately.

To be released in 2020

SPARE PARTS

Designation	Sealing screw	Wrench (Optional)
CGP32-*D-CHP	SGC340	CRW33

■ Use the tool block CTBU25-32-CHP. (p.51)



Caution

Newly developed clamp

Insert is clamped by the elastic deformation of upper jaw. Low clamping stress increases the stability and tool life.



Reference pages: Inserts → **P.20 - 33**, Tool block → **P.51**
Standard cutting conditions → **P.58**, Parts for coolant hose → **P.60**

CGP

External deep grooving and parting blade

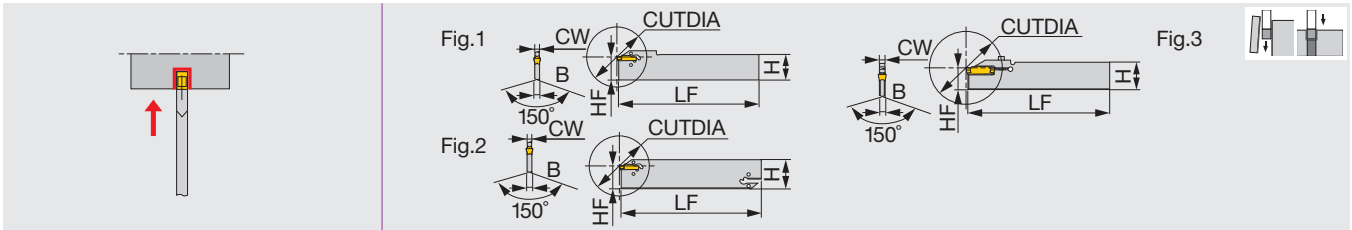

Designation	CW	Seat size	CUTDIA	H	B	LF	HF	Fig.	Torque*
CGP26-1.4S	1.4	1	26	26	1	150	21.4	1	-
CGP32-1.4D	1.4	1	26	32	1	150	24.8	2	-
CGP26-2S	2	2	40	26	1.8	150	21.4	1	-
CGP32-2D	2	2	50	32	1.8	150	24.8	2	-
CGP26-3S	3	3	50	26	2.4	150	21.4	1	-
CGP32-3D	3	3	100	32	2.4	150	24.8	2	-
CGP26-4S	4	4	80	26	3.2	150	21.4	1	-
CGP32-4D	4	4	100	32	3.2	150	24.9	2	-
CGP45-4D	4	4	120	45	3.2	150	38.1	2	-
CGP32-5D	5	5	120	32	4	150	24.9	2	-
CGP32-6D	6	6	120	32	5.2	150	24.9	2	-
CGP32-8S-CL	8	8	80	32	6.2	150	24.9	3	3

When depth is deeper than (insert length - 1.5mm), 1 corner type is recommended.

* CUTDIA Max. parting dia

*Torque: Recommended clamping torque (N·m)

Wrench (CRW...) is not included. Please order it separately.

SPARE PARTS

Designation	Clamping screw	Wrench	Wrench (Optional)
CGP**-1.4*	-	-	CRW23
CGP**-2/3/4/5/6	-	-	CRW33
CGP32-8S-CL	CM4X0.7X20-M0-A	P-3	-

Reference pages: Inserts → **P.20 - 33**, Tool block → **P.51 - 52**
Standard cutting conditions → **P.58**

CTBU

Tool block for GGP blades

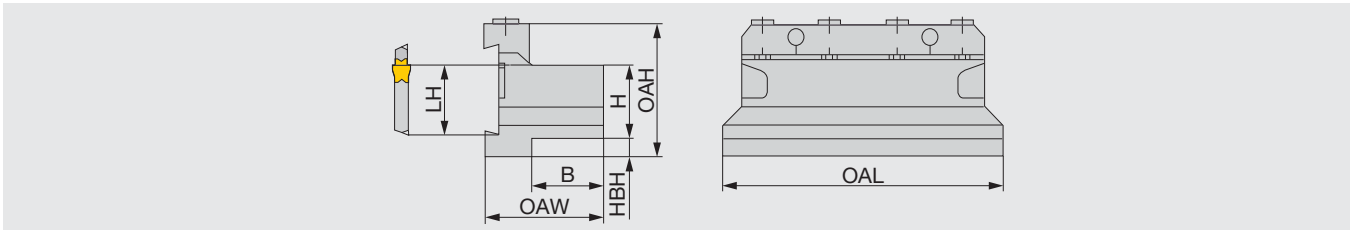

Designation	H	B	OAL	LH	HBH	OAH	OAW	Blade (Optional)
CTBU20-26	20	21	86	21.4	9	43	38	CGP26...
CTBU25-26	25	23	110	21.4	5	45	43	CGP26...
CTBU20-32	20	19	100	24.8	13	50	38	CGP32...
CTBU25-32	25	23	110	24.8	8	50	42	CGP32...
CTBU32-32	32	29	110	24.8	5	54	48	CGP32...

SPARE PARTS

Designation	Clamp	Clamping screw	Wrench
CTBU20-26	CT-86	CM6X30-S	P-5
CTBU25-26	CT-105	CM6X30-S	P-5
CTBU20-32	CT-100	CM6X30-S	P-5
CTBU25-32	CT-110	CM6X30-S	P-5
CTBU32-32	CT-110	CM6X30-S	P-5

CTBU-CHP

Tool blocks for high pressure coolant

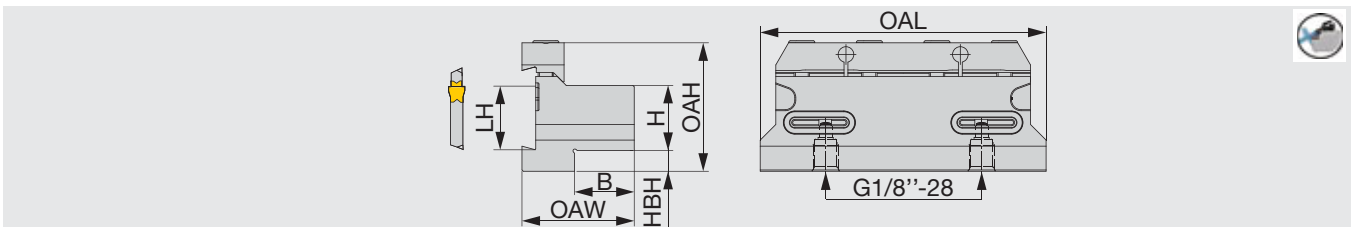

Designation	H	B	OAL	LH	HBH	OAH	OAW	Blade (Optional)
CTBU25-32-CHP	25	23	110	24.8	8	50	43.2	CGP32-*D-CHP

Applicable for 14 MPa coolant

SPARE PARTS

Designation	Clamping screw	Clamp	Wrench	O-ring
CTBU25-32-CHP	SRM6X16DIN912-12.9	CT-110	P-5	OR14X2.5NN

Reference pages: Blades → [P.49 - 50](#), Parts for coolant hose → [P.60](#)

CTBF

Tool block for CGP blades (fixed clamp)

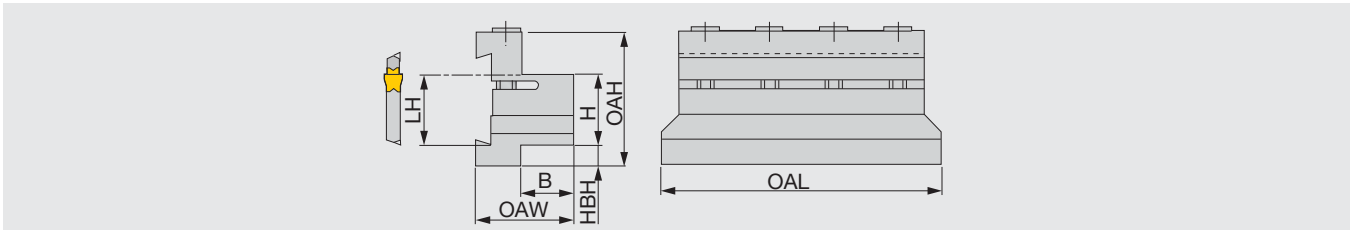

Designation	H	B	OAL	LH	HBH	OAH	OAW	Blade (Optional)
CTBF25-45	25	22	110	38.1	25	66	40	CGP45...
CTBF32-45	32	28	120	38.1	18	66	45	CGP45...

SPARE PARTS

Designation	Clamping screw	Wrench
CTBF...	CM6X1.0X40-A	P-5

C-TBK-R/L

Adapter for parting blades

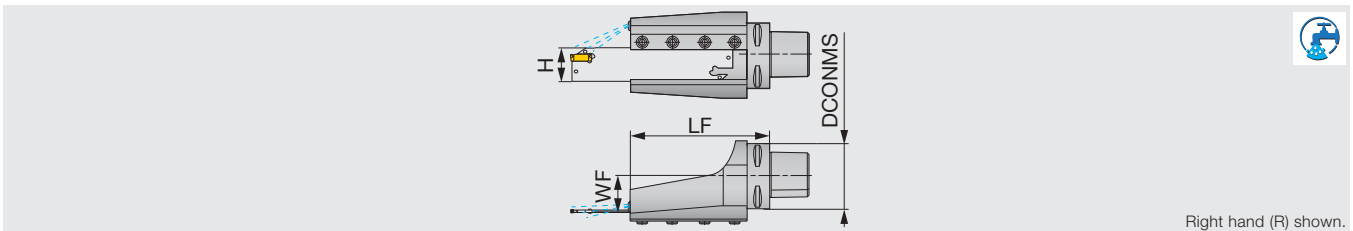

Right hand (R) shown.

Designation	DCONMS	WF	LF	H
C6TBK-32R/L	63	32	138	32

Applicable for 3 MPa coolant

SPARE PARTS

Designation	Clamp	Clamping screw	Wrench	Coolant parts
C6TBK-32R/L	BK32-9WEDG	SRM6X16DIN912-12.9	HW5.0	EZ125

CTER/L-15A

Square shank toolholder for profiling aluminium wheel

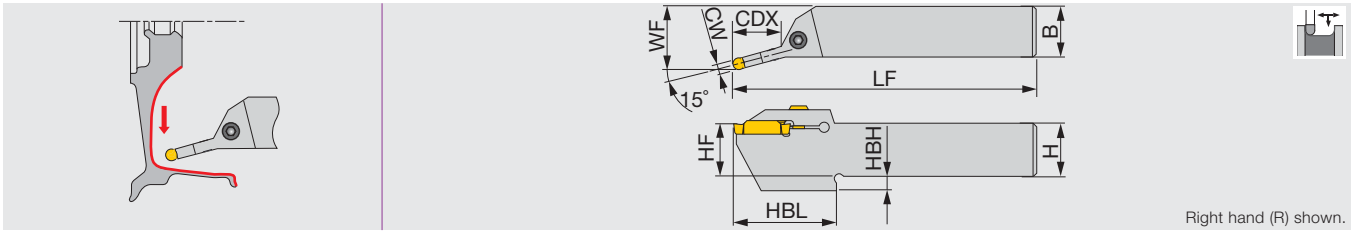

Right hand (R) shown.

Designation	CW	Seat size	CDX	H	B	LF	HF	WF	HBH	HBL	Insert	Torque*
CTER/L2525-6T25-15A	6	6	25	25	25	150	25	32.2	7	50.5	DTA...	5
CTER/L2525-8T30-15A	8	8	30	25	25	150	25	32.9	7	55	DTA...	5

*Torque: Recommended clamping torque (N·m)

SPARE PARTS

Designation	Clamping screw	Wrench
CTER/L2525-****-15A	CM6X1X25-A	P-5

CGIUR/L-15A

Round-shank toolholder for profiling aluminium wheel

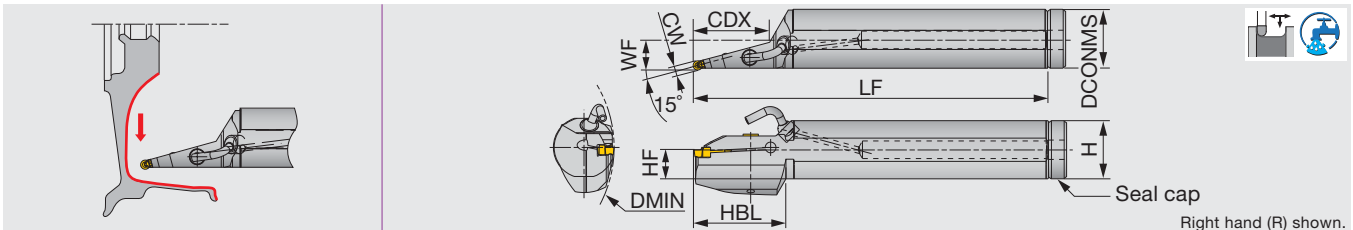

Right hand (R) shown.

Designation	CW	DMIN	Seat size	CDX	DCONMS	H	WF	LF	HF	HBL	Insert	Seal cap	Torque*
CGIUR/L40-6T50-D160-15A	6	160	6	50	40	38.5	19.7	320	19	60	DTA...	CA-40	5
CGIUR/L40-8T83-D160-15A	8	160	8	83	40	38.5	20.5	320	19	85	DTA...	CA-40	5
CGIUR/L50-6T85-D200-15A	6	200	6	85	50	48.5	25.2	350	23.5	85	DTA...	-	5
CGIUR/L50-8T85-D200-15A	8	200	8	85	50	48.5	25.9	350	23.5	85	DTA...	-	5

*Torque: Recommended clamping torque (N·m)

SPARE PARTS

Designation	Clamping screw	Wrench	Seal cap
CGIUR/L*-15A	CM6X1X25-A	P-5	CA-40

NOZZLE

Coolant pipe	Coolant nozzle
PNZ5	CNZ125

CAER/L

External grooving, parting, and turning blade

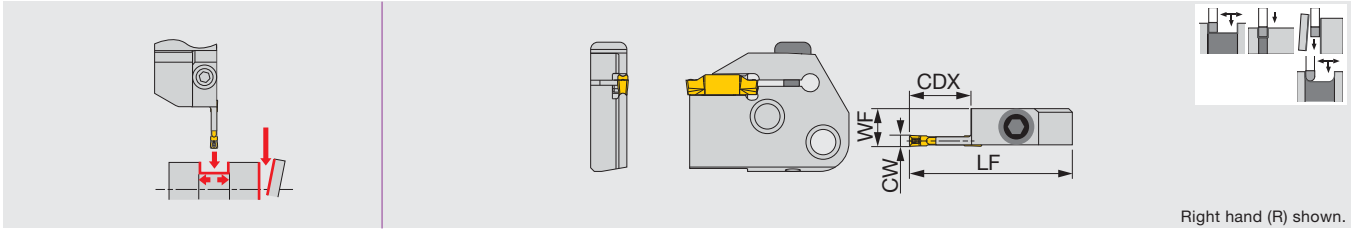

Designation	CW	Seat size	CDX	LF	WF	Shank	Torque*
CAER/L-3T16	3	3	16	45	10.4	CHSR/L..., CHFVL/R...	5
CAER/L-4T16	4	4	16	45	10.5	CHSR/L..., CHFVL/R...	5
CAER/L-5T20	5	5	20	49	10.5	CHSR/L..., CHFVL/R...	5
CAER/L-6T20	6	6	20	49	10.5	CHSR/L..., CHFVL/R...	5

*Torque: Recommended clamping torque (N·m)

Not compatible with TungModularSystem

When groove depth is larger than insert length - 1.5 mm, please use 1-cornered insert.

SPARE PARTS



Designation	Clamping screw	Wrench
CAER/L...	BHM6-20-A	P-4

CAFR/L

Face grooving and turning blade

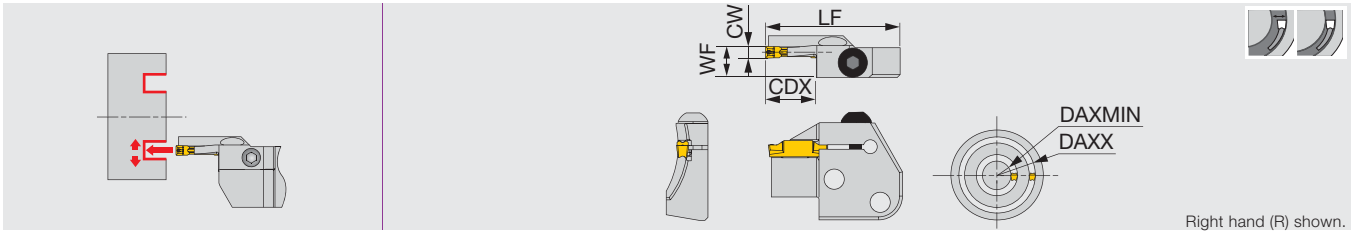

Designation	CW	DAXMIN	DAXX	Seat size	CDX	LF	WF ⁽¹⁾	Torque*
CAFR/L-3T12-040055	3	40	55	3	12	45	10.4	5
CAFR/L-3T12-055075	3	55	75	3	12	45	10.4	5
CAFR/L-3T12-075100	3	75	100	3	12	45	10.4	5
CAFR/L-3T12-100140	3	100	140	3	12	45	10.4	5
CAFR/L-3T12-140200	3	140	200	3	12	45	10.4	5
CAFR/L-4T16-050070	4	50	70	4	16	45	10.5	5
CAFR/L-4T16-070100	4	70	100	4	16	45	10.5	5
CAFR/L-4T16-100150	4	100	150	4	16	45	10.5	5
CAFR/L-4T16-150250	4	150	250	4	16	45	10.5	5
CAFR/L-5T20-055080	5	55	80	5	20	49	10.5	5
CAFR/L-5T20-080120	5	80	120	5	20	49	10.5	5
CAFR/L-5T20-120180	5	120	180	5	20	49	10.5	5
CAFR/L-5T20-180300	5	180	300	5	20	49	10.5	5
CAFR/L-5T20-300000	5	300	∞	5	20	49	10.5	5
CAFR/L-6T25-060090	6	60	90	6	25	55	10.5	5
CAFR/L-6T25-090150	6	90	150	6	25	55	10.5	5
CAFR/L-6T25-150250	6	150	250	6	25	55	10.5	5
CAFR/L-6T25-250400	6	250	400	6	25	55	10.5	5

When groove depth is larger than (insert length - 1.5 mm), please use 1-cornered insert.
Max. groove depth will be 15 mm with DTF insert.

Use the right-hand insert for the right-hand holder with DTF insert.

Not compatible with TungModularSystem

(1)WF is calculated with the groove width (CW) in the above table.

(2) Not applicable to CAFR/L-3T12-040055

(3) Seat sizes of DTF are only 3 and 4.

*Torque: Recommended clamping torque (N·m)

SPARE PARTS

Designation	Clamping screw	Wrench
CAFR/L...	BHM6-20-A	P-4

Insert	Groove width CW	Face grooving Min. machining dia. DAXMIN
DGM / DGS / SGN / DGL	3	92
DGM / DGS / SGN / DGL	4	37
DGM / DGS / DGL	5	60
DGM / DGS / DGL	6	57
DTE / DGG / DTM	3	62
DTE / DGG / DTM	4	42
DTE / DGG / DTM	5	64
DTE / DGG / DTM	6	61
DTR	3	44
DTR	4	32
DTR	5	48
DTR	6	48
DTX	3	22
DTX	4	20
DTX	5	20
DTX	6	23
DTF	3	20
DTF	4	20

CHSR/L

Shank for CAER/L and CAFR/L blades

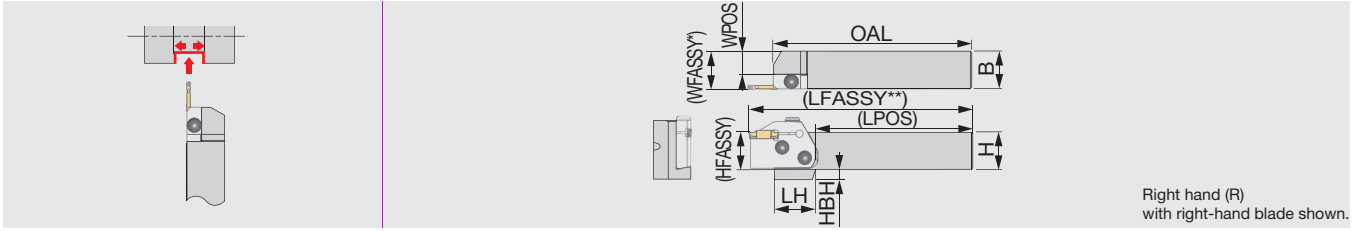

Right hand (R)
with right-hand blade shown.

Designation	H	B	OAL	LPOS	LH	WPOS	HFASSY	HBH	Blade (Option)
CHSR/L2020	20	20	133	105	35	10	20	12	CAER/L..., CAFL/R...
CHSR/L2525	25	25	133	105	28	15	25	7	CAER/L..., CAFL/R...
CHSR/L3232	32	32	153	125	-	22	32	-	CAER/L..., CAFL/R...

*WFASSY : Shank (WPOS) + blade (WF)

**LFASSY : Shank (LPOS) + blade (LF)

Not compatible with TungModularSystem

SPARE PARTS

Designation	Clamping screw	Wrench
CHSR/L...	CSHB-6-A	P-4

CHFVR/L

Shank for CAER/L and CAFR/L blades

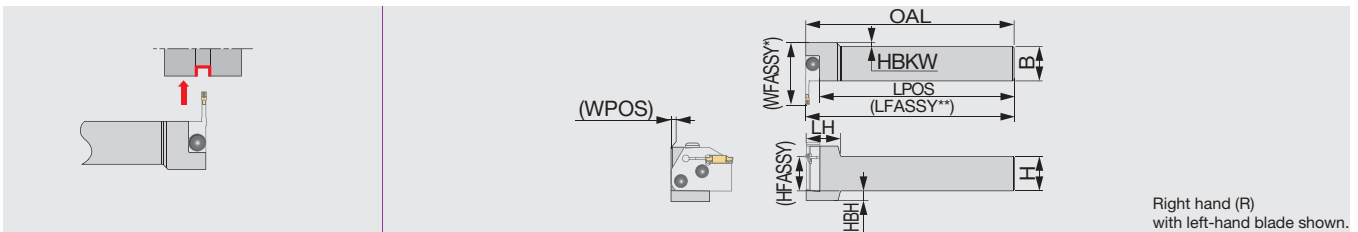

Right hand (R)
with left-hand blade shown.

Designation	H	B	OAL	LPOS	LH	WPOS	HBKW	HFASSY	HBH	Blade (Option)
CHFVR/L2020	20	20	150	140	25	0	8	20	12	CAEL/R..., CAFR/L...
CHFVR/L2525	25	25	150	140	25	0	3	25	7	CAEL/R..., CAFR/L...
CHFVR/L3232	32	32	170	160	25	4	-	32	-	CAEL/R..., CAFR/L...

*WFASSY : Shank (WPOS) + blade (LF)

**LFASSY : Shank (LPOS) + blade (WF)

Not compatible with TungModularSystem

SPARE PARTS

Designation	Clamping screw	Wrench
CHFVR/L...	CSHB-6-A	P-4

Combination of blade and toolholder

Toolholder	Blade			
	CAER...	CAEL...	CAFR...	CAFL...
CHSR...	●			●
CHSL...		●	●	
CHFVR...		●	●	
CHFVL...	●			●

● : Corresponding

Reference pages: Inserts → P.20 - 33, Blades → P.54 - 55, Standard cutting conditions → P.58

C-CHSR/L

TungCap shank for CAER/L and CAFR/L blades

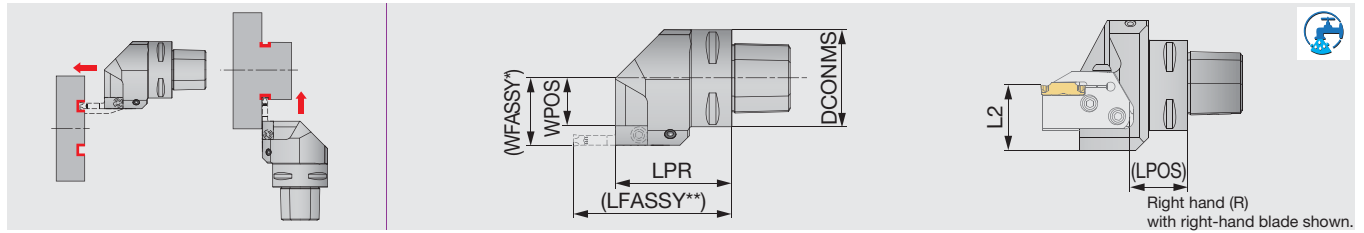

Designation	DCONMS	LPR	LPOS	L2	WPOS	Blade (Option)
C3CHSR/L22050N	32	50	22.1	35	11.5	CAER/L..., CAFL/R...
C4CHSR/L27050N	40	50	22.1	36	16.5	CAER/L..., CAFL/R...
C5CHSR/L35060N	50	60	32.1	36	24.5	CAER/L..., CAFL/R...
C6CHSR/L45065N	63	65	32.1	41	34.5	CAER/L..., CAFL/R...

*WFASSY : Shank (WPOS) + blade (WF)

**LFASSY : Shank (LPOS) + blade (LF)

Applicable for 7 MPa coolant. Not compatible with TungModularSystem.

SPARE PARTS

Designation	Coolant parts	Clamping screw	Wrench
C3CHSR/L22050N	SATZ-M8X1-M3	CSHB-6-A	P-4
C4CHSR/L27050N	SATZ-M8X1-M3	CSHB-6-A	P-4
C5CHSR/L35060N	SATZ-M10X1-M5	CSHB-6-A	P-4
C6CHSR/L45065N	SATE-M10X1-M5	CSHB-6-A	P-4

C-CHFVR/L

TungCap shank for CAER/L and CAFR/L blades

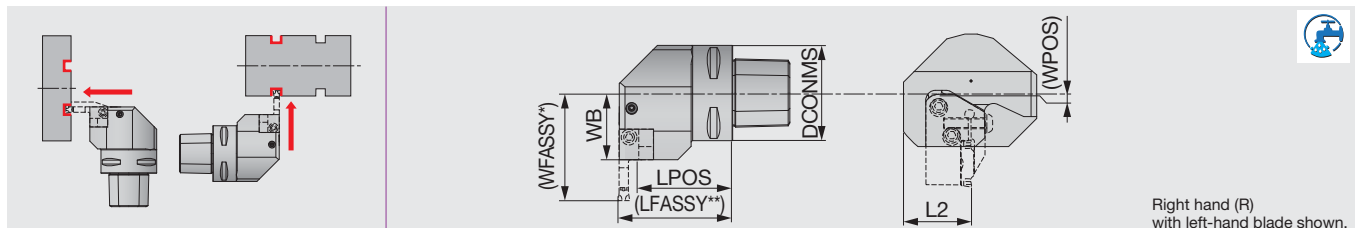

Designation	DCONMS	LPOS	L2	WB	WPOS	Blade (Option)
C3CHFVR/L22040N	32	32.5	35	22	-5.9	CAEL/R..., CAFR/L...
C4CHFVR/L27050N	40	42.5	36	27	-0.9	CAEL/R..., CAFR/L...
C5CHFVR/L35060N	50	49.5	36	35	7.1	CAEL/R..., CAFR/L...
C6CHFVR/L45065N	63	54.5	41	45	17.1	CAEL/R..., CAFR/L...

*WFASSY : Shank (WPOS) + blade (LF)

**LFASSY : Shank (LPOS) + blade (WF)

Applicable for 7 MPa coolant. Not compatible with TungModularSystem.

SPARE PARTS

Designation	Coolant parts	Clamping screw	Wrench
C3CHFVR/L22040N	SATZ-M8X1-M3	CSHB-6-A	P-4
C4CHFVR/L27050N	SATZ-M8X1-M3	CSHB-6-A	P-4
C5CHFVR/L35060N	SATZ-M10X1-M5	CSHB-6-A	P-4
C6CHFVR/L45065N	SATZ-M10X1-M5	CSHB-6-A	P-4

Combination of blade and toolholder

Toolholder	Blade			
	CAER...	CAEL...	CAFR...	CAFL...
C*CHSR...	●			●
C*CHSL...		●	●	
C*CHFVR...		●	●	
C*CHFVL...	●			●

● : Corresponding

Reference pages: Inserts → P.20 - 33, Blades → P.54 - 55, Standard cutting conditions → P.58

STANDARD CUTTING CONDITIONS

ISO	Workpiece material	Hardness	Priority	Grade	Cutting speed Vc (m/min)
P	Steels (C45, 34CrMo4, etc.)	< 300 HB	First choice	AH7025, AH725	50 - 180
		< 300 HB	Priority for wear resistance	New T9225	80 - 300
		< 300 HB	Priority for wear resistance	T9125	80 - 200
		< 300 HB	Priority for impact resistance	GH130	50 - 120
		< 300 HB	Priority for surface finish	NS9530	80 - 220
M	Stainless steel (X10CrNiS18-9, etc.)	< 200 HB	First choice	AH7025, AH725	50 - 120
		< 200 HB	Priority for impact resistance	GH130	50 - 120
K	Gray cast iron (GG25, 250, etc.)	-	First choice	T515, AH7025	50 - 180
		-	Priority for impact resistance	GH130	50 - 180
	Ductile cast irons (GGG45, 450-10S, etc.)	-	First choice	T515, AH7025	50 - 120
		-	Priority for impact resistance	GH130	50 - 120
N	Aluminium alloys (Si < 12%)	-	First choice	TH10	100 - 500
		-	First choice	KS05F	100 - 600
S	Superalloys (Inconel718, etc.)	< HRC 40	First choice	AH7025	20 - 60
		< HRC 40	Priority for wear resistance	AH905	20 - 80
	Titanium alloys Ti-6Al-4V, etc.	< HRC 40	First choice	AH905	20 - 80
		< HRC 40	Priority for impact resistance	AH7025, AH725	20 - 80
		< HRC 40	Priority for surface finish	KS05F	20 - 60
H	Hardened steels (34CrMo4, etc.)	> HRC 50	First choice	BX360	80 - 150

*Please see the page P15 - 19 for feed: f (mm/rev).

TUNG M^{ODULAR} SYSTEM

HOW TO INSTALL AND REMOVE THE BLADE AND INSERT

Assembly

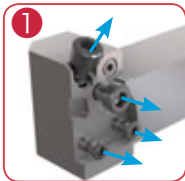

1 Remove all 4 screws and ensure the O rings are all in place.

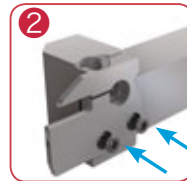

2 Place the blade and tighten 2 bottom clamping screws.

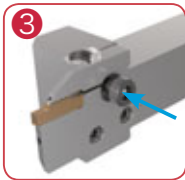

3 Place the insert in the pocket and tighten the fixing screw in the center.

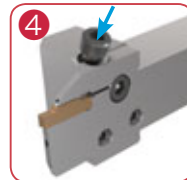

4 Place the long screw in the angular direction and tighten to clamp the insert.

Please follow the installation order as shown above. When the screws are tightened in the 4 → 3 order, the insert clamping may be insufficient and unstable.

Disassembly

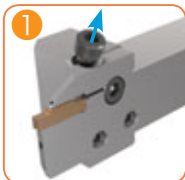

1 First loosen the long screw in the angular direction.

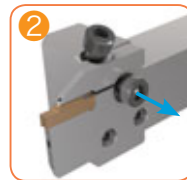

2 Loosen the Fixing screw in the center and remove the insert.

Loosening the long screw alone may not release the insert.

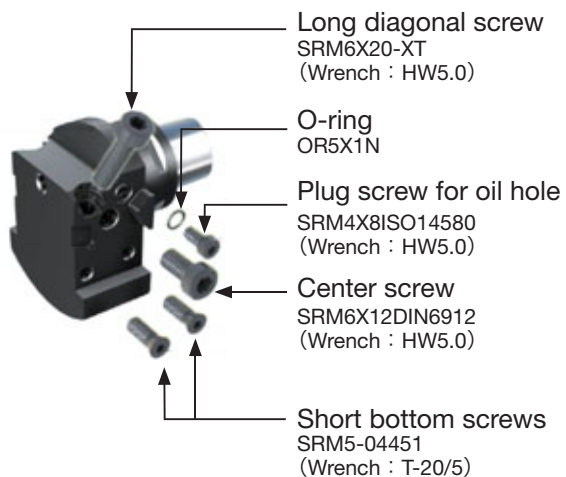
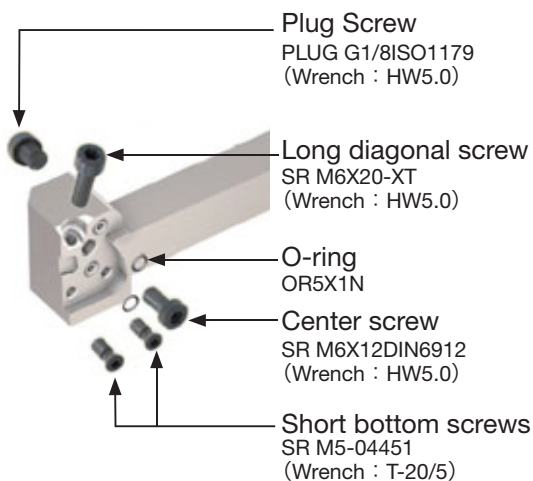

* All parts listed here are included in the tool holder.

PARTS FOR COOLANT HOSE

Connecting hose

Fig.1

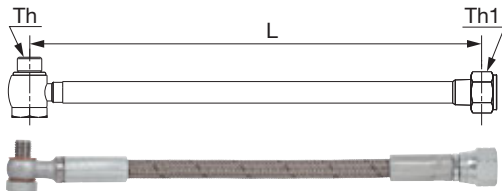
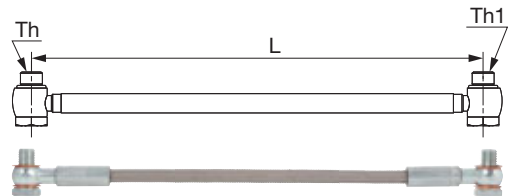
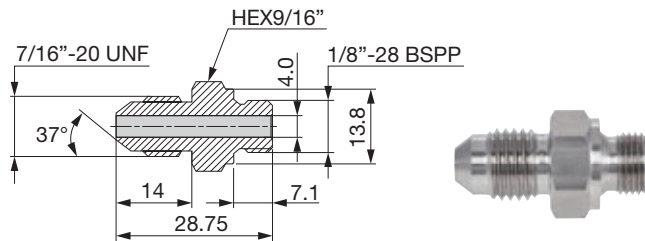

Fig.2



Designation	Length L	Th	Screw		Max. pressure (Mpa)	Fig.
			Th1			
CHP-HOSE-G1/8-7/16-200BS	200	G1/8"-28 BSPP	7/16"-20 UNF		26	1
CHP-HOSE-G1/8-7/16-250BS	250	G1/8"-28 BSPP	7/16"-20 UNF		26	1
CHP-HOSE-5/16-7/16-200BS	200	5/16"-24UNF	7/16"-20 UNF		20	1
CHP-HOSE-5/16-G1/8-200BS	200	5/16"-24UNF	G1/8"-28 BSPP		20	1
CHP-HOSE-G1/8-G1/8-200BB	200	G1/8"-28 BSPP	G1/8"-28 BSPP		26	2
CHP-HOSE-G1/8-G1/8-250BB	250	G1/8"-28 BSPP	G1/8"-28 BSPP		26	2

Adapter



Designation

CHP-NIPPLE-G1/8-7/16UNF

Seal washer



Designation

Designation	øD	ød	W
CHP-COPPER-SEAL1/8	15	10	1
CHP-COPPER-SEAL5/16	11	8	1
CHP-COPPER-SEAL5/16-2.5	11	8	2.5

Connector for small lathe with seal washer

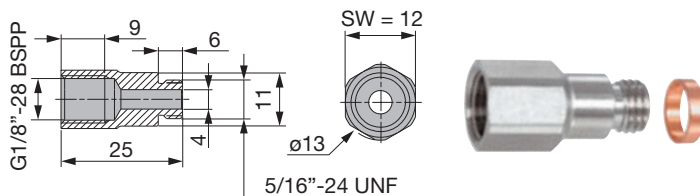

Designation

CHP-CONNECTOR5/16-G1/8

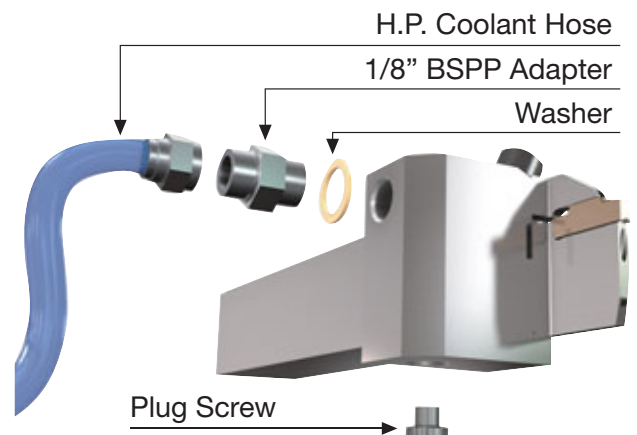

DIRECT^{TUNG}JET system

Tube-less design streamlines tool setup
Through-coolant supply enables high productivity

DirectTungJet system

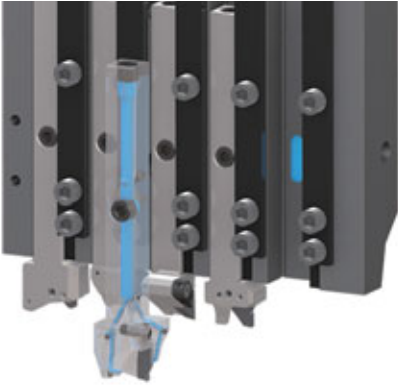

No need for coolant tube setup.
Eliminates chip entanglement on tubes
and streamlines tool replacements.

Coolant is supplied from the tool post
directly to the tools

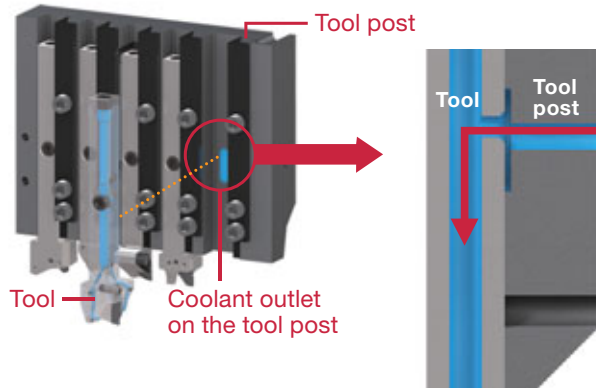

GUIDELINE FOR ORDERING SPECIAL INSERTS

Specially designed inserts are available upon request.

Acceptable specification

- Special inserts are manufactured from the base insert styles shown below.

* Please contact Tungaloy for more details.

External grooving & turning		Internal grooving & turning	Profiling & undercutting	
DTE (Ground)	DGE (Ground)	DTI (Ground)	DTR (Ground)	DTIU (Ground)
				

DESIGNATION SYSTEM FOR SPECIAL INSERTS (sample)

DTE	320	- 000R-025L	AH725
① Main style of insert	② Max. width of insert	③ Additional codes	④ Grade

SHAPE SAMPLES

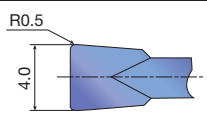
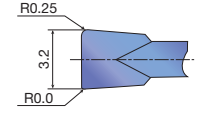
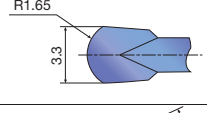
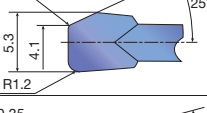
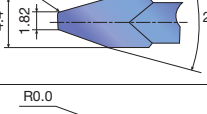
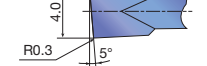
Shape	Samples of designation	Note
	DTE400-050 AH7025	Base style: DTE type Special corner radius
	DTE320-000R 025L AH725	Base style: DTE type Special corner radius, asymmetric type
	DTR330-165 T515	Base style: DTR type Full radius type with special insert width
	DTE530-120R-25LA T9225	Base style: DTE type Special figure of groove, asymmetric type
	DGG440-035-29A KS05F	Base style: DTE type Special figure of groove
	DTE400-030R-005RA NS9530	Base style: DTE type Right handed insert with special angle and corner radius.

Expedited delivery service for special grooving insert

Expedited delivery service for special grooving inserts is rendered under the following lead time and quantity terms. Please note that this service is applicable only for the order for an initial test batch; a repeat order is to be placed through the regular ordering process.

ORDER
3 - 15 pcs.



LEAD TIME
from the point of order receipt
(excluding transportation)

COATED INSERT
4 weeks

NON-COATED INSERT
3 weeks



DELIVERY

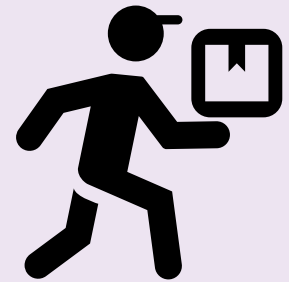

TUNGCUT
TUNGALOY

Special width
& corner radii



With chamfer
edges



DGN Chipbreaker



DTE Chipbreaker



	Grade	
	Coated carbide	Cermet
	AH725	NS9530
DGN200	•	•
DGN300	•	•
DGN400	•	•
DGN500	•	•
DGN600	•	•
DTE300	•	•
DTE400	•	•
DTE500	•	•
DTE600	•	•
DTE800	•	

Special width & corner radii

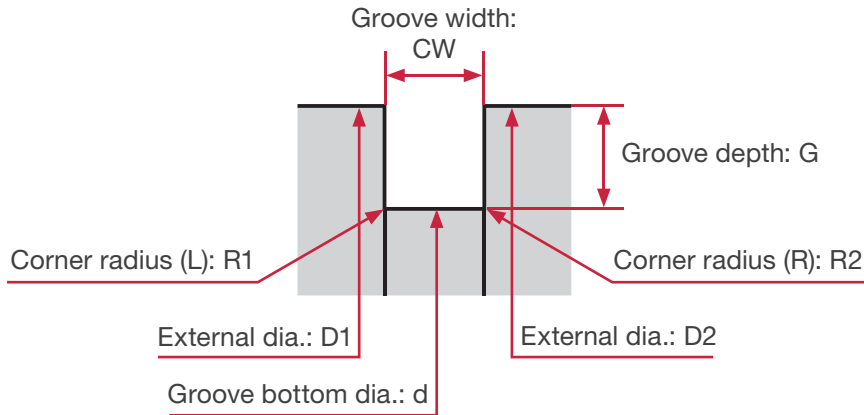

Edge type	Insert blank	Seat size	Groove width (CW)	Max. groove depth (G)	Corner radii (R1 / R2)	Toolholder
A	DGN* DTE*	2 - 6	0.50 - 0.74 mm	- 1.5 mm	0 or 0.05 - W/2 (Full radius is available)	CTEFR/L
			0.75 - 0.99 mm	- 1.8 mm		
			1.0 - 1.49 mm	- 2.5 mm		
			1.50 - 6.00 mm	- 4.8 mm		
	DGN300/DTE300	3	2.65 - 3.0 mm	Up to holder (Max.18 mm)		CTER/L
	DGN400/DTE400	4	3.30 - 4.0 mm			CTEFR/L
B	DGN500/DTE500	5	4.20 - 5.0 mm	Up to holder (Max.28 mm)		CTEFR/L
		DGN600/DTE600	6	5.20 - 6.0 mm		
		DTE800	8	6.40 - 8.0 mm		CTER/L

*Tolerances of the insert are based on the standard item.



Edge type A



Edge type B

Grooving & chamfering

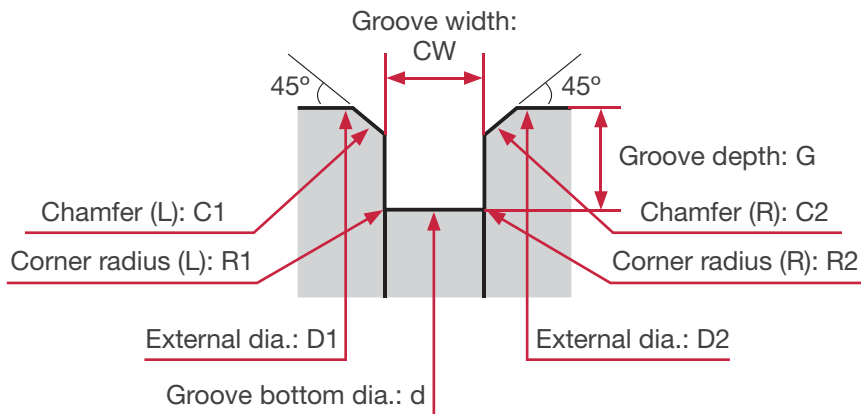





Insert blank	Seat size	Groove width (CW)	Max. groove depth (G)	Corner radii (R1 / R2)	Toolholder
DGN200 DGN300	2 - 6	1.0 - 4.8 mm	1.0 - 4.0 mm	0 or	CTEFR/L
DGN400 DGN500 DGN600				0.05 - W/2 (Full radius is available)	CTEFR/L (Modified)

*Tolerances of the insert are based on the standard item.

Max. width of chamfer is 0.5 mm.

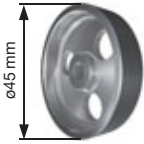
Some combinations of a groove width, depth, a corner radius(R), and chamfer may be unable to be manufactured.

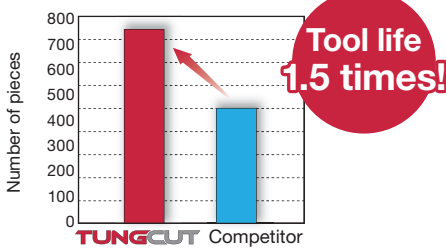
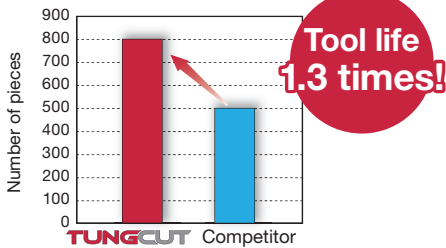
PRACTICAL EXAMPLES

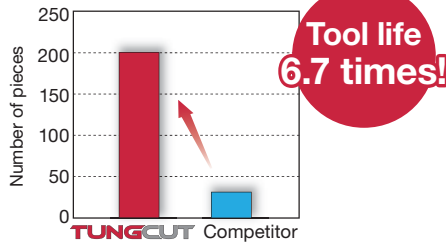
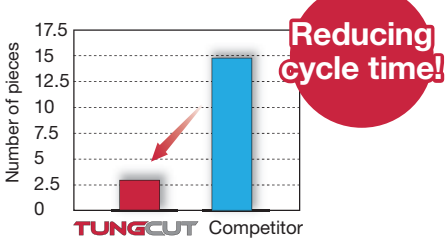
Workpiece type		Ring encoder	Gear Housing
Toolholder		CTER2020-4T25	CTER2525-3T09
Insert		DGM4-030	DTX3-030
Grade		AH7025	AH725
Workpiece material		SUM22L  P	SCM420 / 20Cr4  P
Cutting conditions	Grooving width : CW (mm)	4	3
	Cutting speed : Vc (m/min)	180	120
	Feed : f (mm/rev)	0.2	0.15
	Cutting edge depth : CDX (mm)	8	7
	Machining	Parting off	Grooving
	Coolant	Wet	Wet
Results		 <p>Tool life 1.5 times!</p> <p>TungCut increased cutting speed and feed. Despite the frequent impacts in parting off, TungCut provided stable machining with no fracture even under high cutting conditions.</p>	 <p>Tool life 1.3 times!</p> <p>The competitor's insert had microchipping issues. TungCut has improved productivity at greater cutting speed and feed rate with no micro-chipping on the cutting edge.</p>
Workpiece type		Valve	Gear Segment
Toolholder		CTIR25-3T05-D250	Special
Insert		DTX3-030	DTX3.8-020
Grade		AH7025	AH7025
Workpiece material		SUS304 / X5CrNi18-9  M	Inconel 718  S
Cutting conditions	Grooving width : CW (mm)	3	3.8
	Cutting speed : Vc (m/min)	80	8
	Feed : f (mm/rev)	0.08	0.02
	Cutting edge depth : CDX (mm)	2.2	7
	Machining	Grooving	Grooving
	Coolant	Wet	Wet
Results		 <p>Tool life 6.7 times!</p> <p>Conventional tool caused vibration, tool life was 30 pcs/edge. TungCut has high rigidity clamping, improving productivity, cutting surface and tool life drastically.</p>	 <p>Reducing cycle time!</p> <p>The shape of the work piece had heavy interrupted cutting. Conventional tool could machine only 2.5pcs per edge before fractured, limiting productivity improvement. AH7025 could increase feed rate without fracture.</p>

PRACTICAL EXAMPLES

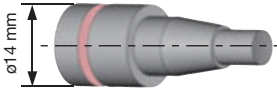
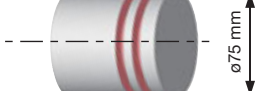
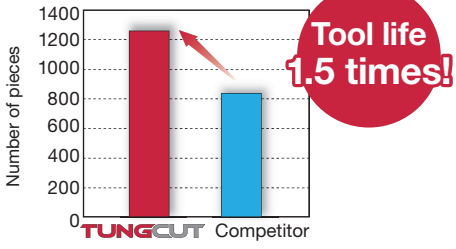
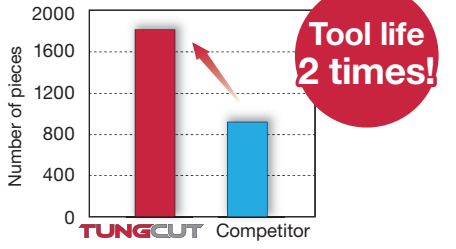
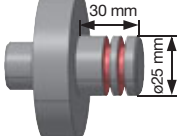
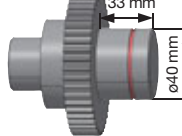
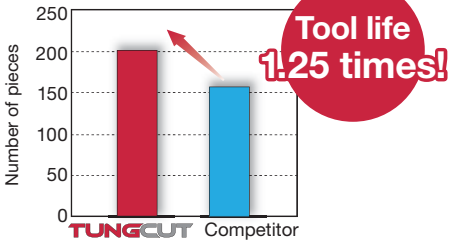
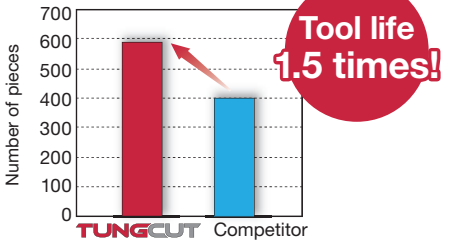
Workpiece type		Automotive parts	Machine parts
Toolholder		CTER1616-2T08	CTER2525-4T10
Insert		DGM2-020	DGM4-030
Grade		AH725	AH725
Workpiece material		SCr440 / 41Cr4	SCr440 / 41Cr4
		 P	 P
Cutting conditions	Grooving width : CW (mm)	2	4
	Cutting speed : Vc (m/min)	94	150
	Feed : f (mm/rev)	0.08	0.10
	Cutting edge depth : CDX (mm)	-	6
	Machining	Parting off	Grooving
	Coolant	Wet	Wet
Results		 TungCut has higher wear resistance and achieves tool life improvements by 150%.	 TungCut provided better chip control doubling tool life.
Workpiece type		Machine parts	Gear
Toolholder		CTEL2020-3T09	CTER2525-2T08
Insert		DTE3-040	SGN200-020
Grade		T9125	BX360
Workpiece material		S53C / C53	SCM415H (58HRC) / 18CrMo4
		 P	 H
Cutting conditions	Grooving width : CW (mm)	3	2
	Cutting speed : Vc (m/min)	200	120
	Feed : f (mm/rev)	0.2	0.05
	Cutting edge depth : CDX (mm)	5	0.8
	Machining	Grooving	Grooving
	Coolant	Wet	Wet
Results		 Excellent wear resistance of TungCut improved tool life by 25% at higher cutting speed.	 TungCut extended tool life by 1.5 times in cutting hardened steel thanks to extremely stable CBN grade.

Tungaloy Corporation (Head office)

11-1 Yoshima-Kogyodanchi
Iwaki-city, Fukushima 970-1144 Japan
Phone: +81-246-36-8501
Fax: +81-246-36-8542
www.tungaloy.co.jp

Tungaloy America, Inc.

3726 N Ventura Drive
Arlington Heights, IL 60004, U.S.A.
Phone: +1-888-554-8394
Fax: +1-888-554-8392
www.tungaloy.com/us

Tungaloy Canada

432 Elgin St. Unit 3
Brantford, Ontario N3S 7P7, Canada
Phone: +1-519-758-5779
Fax: +1-519-758-5791
www.tungaloy.com/ca

Tungaloy de Mexico S.A.

C Los Arellano 113,
Parque Industrial Siglo XXI
Aguascalientes, AGS, Mexico 20290
Phone: +52-449-929-5410
Fax: +52-449-929-5411
www.tungaloy.com/mx

Tungaloy do Brasil Ltda.

Avd. Independencia N4158 Residencial Flora
13280-000 Vinhedo, São Paulo, Brasil
Phone: +55-19-38262757
Fax: +55-19-38262757
www.tungaloy.com/br

Tungaloy Germany GmbH

An der Alten Ziegelei 1
D-40789 Monheim, Germany
Phone: +49-2173-90420-0
Fax: +49-2173-90420-19
www.tungaloy.de

Tungaloy France S.A.S.

ZA Courtaboef - Le Rio
1 rue de la Terre de feu
F-91952 Courtaboef Cedex, France
Phone: +33-1-6486-4300
Fax: +33-1-6907-7817
www.tungaloy.com/fr

Tungaloy Italia S.r.l.

Via E. Andolfato 10
I-20126 Milano, Italy
Phone: +39-02-252012-1
Fax: +39-02-252012-65
www.tungaloy.com/it

Tungaloy Czech s.r.o.

Turanka 115
CZ-627 00 Brno, Czech Republic
Phone: +420-532 123 391
Fax: +420-532 123 392
www.tungaloy.com/cz

Tungaloy Ibérica S.L.

C/Miquel Servet, 43B, Nau 7
Pol. Ind. Bufalvent
ES-08243 Manresa (BCN), Spain
Phone: +34 93 113 1360
Fax: +34 93 876 2798
www.tungaloy.com/es

Tungaloy Scandinavia AB

Bultgatan 38
442 40 Kungälv, Sweden
Phone: +46-462119200
Fax: +46-462119207
www.tungaloy.com/se

Tungaloy Rus, LLC

Andropova avenue, h.18/7,
11 floor, office 3, 115432,
Moscow, Russia
Phone: +7-499-683-01-80
Fax: +7-499-683-01-81
www.tungaloy.com/ru

Tungaloy Polska Sp. z o.o.

Ul. Irysowa 1, 55-040 Bielany
Wroclawskie, Poland
Phone: +48 607 907 237
www.tungaloy.com/pl

Tungaloy U.K. Ltd

Gallan Park, Watling Street,
Cannock, WS110XG, UK
Phone: +44 121 4000 231
Fax: +44 121 270 9694
www.tungaloy.com/uk

Tungaloy Hungary Kft

Erzsébet királyné útja 125
H-1142 Budapest, Hungary
Phone: +36 1 781-6846
Fax: +36 1 781-6866
www.tungaloy.com/hu

Tungaloy Turkey

Dudullu, OSB 4. Cad No:4
34776 Umraniye Istanbul, TURKEY
Phone: +90 216 540 04 67
Fax: +90 216 540 04 87
www.tungaloy.com/tr

Tungaloy Benelux b.v.

Tjalk 70
NL-2411 NZ Bodegraven, Netherlands
Phone: +31 172 630 420
Fax: +31 172 630 429
www.tungaloy.com/nl

Tungaloy Croatia

Ulica bana Josipa Jelačića 87,
10430, Samobor, Croatia
Phone: +385 1 3326 604
Fax: +385 1 3327 683
www.tungaloy.com/hr

Tungaloy Cutting Tool (Shanghai) Co., Ltd.

Rm No 401 No.88 Zhabei
Jiangchang No.3 Rd
Shanghai 200436, China
Phone: +86-21-3632-1880
Fax: +86-21-3621-1918
www.tungaloy.com/cn

Tungaloy Cutting Tools (Taiwan) Co., Ltd.

9F, No.293, Zhongyang Rd,
Xinzhuang Dist, New Taipei City,
24251 Taiwan
Phone: +886-2-8521-9986
Fax: +886-2-8521-8935
www.tungaloy.com/tw

Tungaloy Cutting Tools (Thailand) Co., Ltd.

Interlink tower 4th Fl.
1858/5-7 Bangna-Trad Road
km.5 Bangna, Bangna, Bangkok 10260
Thailand
Phone: +66-2-751-5711
Fax: +66-2-751-5715
www.tungaloy.com/th

Tungaloy Singapore (Pte.), Ltd.

62 Ubi Road 1, #06-11 Oxley BizHub 2
Singapore 408734
Phone: +65-6391-1833
Fax: +65-6299-4557
www.tungaloy.com/sg

Tungaloy Vietnam

LE04.38, Lexington Residence
67 Mai Chi Tho St., Dist. 2,
Ho Chi Minh City, Vietnam
Phone: +84-2837406660
www.tungaloy.com/sg

Tungaloy India Pvt. Ltd.

Indiabulls Finance Centre,
Unit # 902-A, 9th Floor,
Tower 1, Senapati Bapat Marg,
Elphinstone Road (West),
Mumbai-400013, India
Phone: +91-22-6124-8804
Fax: +91-22-6124-8899
www.tungaloy.com/in

Tungaloy Korea Co., Ltd

#1312, Byucksan Digital Valley 5-cha
Beotkkot-ro 244, Geumcheon-gu
153-788 Seoul, Korea
Phone: +82-2-2621-6161
Fax: +82-2-6393-8952
www.tungaloy.com/kr

Tungaloy Malaysia Sdn Bhd

50 K-2, Kelana Mall, Jalan SS6/14
Kelana Jaya, 47301
Petaling Jaya, Selangor Darul Ehsan
Malaysia
Phone: +603-7805-3222
Fax: +603-7804-8563
www.tungaloy.com/my

Tungaloy Australia Pty Ltd

Unit 68 1470 Ferntree Gully Road
Knoxfield 3180 Victoria, Australia
Phone: +61-3-9755-8147
Fax: +61-3-9755-6070
www.tungaloy.com/au

PT. Tungaloy Indonesia

Kompleks Grand Wisata Block AA-10 No.3-5
Cibitung
Bekasi 17510, Indonesia
Phone: +62-21-8261-5808
Fax: +62-21-8261-5809
www.tungaloy.com/id



www.tungaloy.com

follow us at:

facebook.com/tungaloyjapan
twitter.com/tungaloyjapan
www.youtube.com/tungaloycorporation



AS9100 Certified
78006
2015.11.04
ISO14001 Certified
EC97J1123
1997.11.26

Distributed by:



FIND US ON THE CLOUD!
machiningcloud.com

